

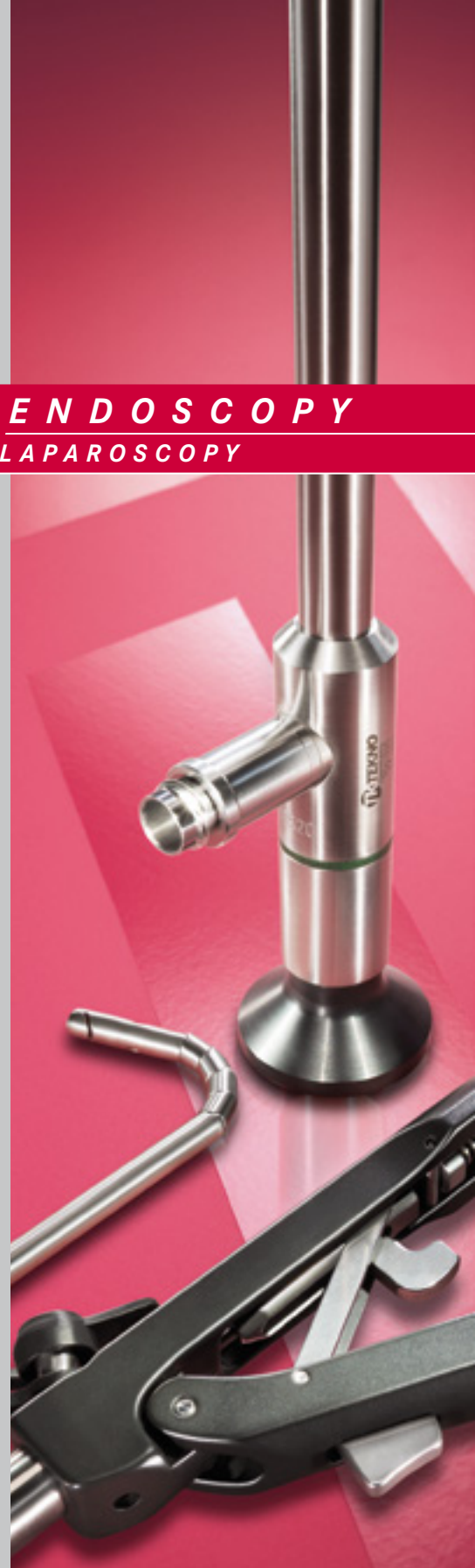

**ENDOSCOPY**  
**LAPAROSCOPY**



Laparoskopie | Laparoscopie  
*Laparoscopy* | *Laparoscopia*  
Laparoscopia

Katalog  
*Catalogue*  
Catalogue  
*Catálogo*  
Catalogo

No. **207**



Kataloge  
Catalogues

Catalogues  
Catálogos  
Cataloghi

SURGERY



Hauptkatalog Chirurgie  
*Main catalogue surgery*  
Catalogue général  
*Catálogo general*  
Catalogo generale

**No. 111**



Plastische Chirurgie  
*Plastic surgery*  
Chirurgie plastique  
*Cirugía plástica*  
Chirurgia plastica

**No. 112**



Ophthalmologie  
*Ophthalmology*  
Ophtalmologie  
*Oftalmologia*  
Oftalmologia

**No. 113**



Traumatologie  
*Traumatology*  
Traumatologie  
*Traumatologia*  
Traumatologia

**No. 114**



Gefäßchirurgie  
*Vascular surgery*  
Chirurgie vasculaire  
*Cirugía vascular*  
Chirurgia vascolare

**No. 115**



Retraktor Systeme  
*Retractor systems*  
Systèmes des écarteurs  
*Sistema de retractores*  
Sistemi di retrattori

**No. 133**



Aneurismen Clips  
*Aneurysm clips*  
Clips pour anévrismes  
*Clips para aneurismas*  
Clips per aneurismi

**No. 134**



HNO Hauptkatalog  
*ENT main catalogue*  
ORL catalogue général  
*ORL catálogo general*  
ORL catalogo generale

**No. 501**

CONTAINER

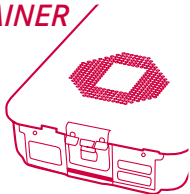

Container I  
*Container I*  
Contenaires I  
*Contenedores I*  
Container I

**No. 302**



Container II  
*Container II*  
Contenaires II  
*Contenedores II*  
Container II

**No. 303**

OR LIGHTS

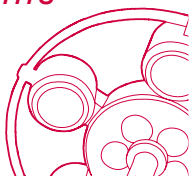

ATRIA 1  
*ATRIA 1*  
ATRIA 1  
*ATRIA 1*  
ATRIA 1

**No. 701**



ATRIA 2  
*ATRIA 2*  
ATRIA 2  
*ATRIA 2*  
ATRIA 2

**No. 702**



ATRIA 3  
*ATRIA 3*  
ATRIA 3  
*ATRIA 3*  
ATRIA 3

**No. 703**



ATRIA 5  
*ATRIA 5*  
ATRIA 5  
*ATRIA 5*  
ATRIA 5

**No. 704**

Kataloge  
Catalogues

Catalogues  
Catálogos  
Cataloghi

ENDOSCOPY

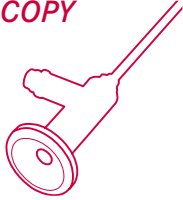

Geräte  
Units  
Appareils  
Equipos  
Apparecchi

No. 205

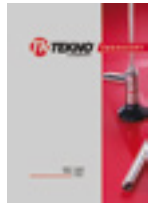

Optiken  
Scopes  
Optiques  
Ópticas  
Ottiche

No. 206



Laparoskopie  
Laparoscopy  
Laparoscopia  
Laparoscopia  
Laparoscopia

No. 207



Urologie  
Urology  
Urologie  
Urología  
Urologia

No. 208



Gynäkologie  
Gynaecology  
Gynécologie  
Ginecología  
Ginecologia

No. 209



Arthroskopie  
Arthroscopy  
Arthroscopie  
Artroscopia  
Artroscopia

No. 210



Sinuskopie  
Sinuscopy  
Sinuscopie  
Sinuscopia  
Sinuscopia

No. 211

ELECTRO SURGERY

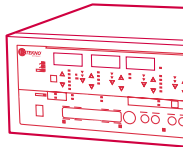

Elektro Chirurgie  
Electro surgery  
Électrochirurgie  
Electro-Cirurgia  
Elettrobisturi

No. 212

DENTAL

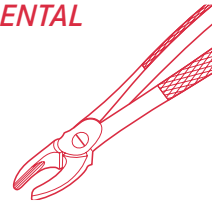

Dental  
Dental  
Dentaire  
Dental  
Dentale

No. 402

OR TABLES

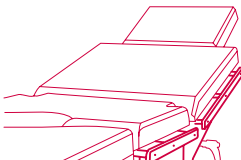

VECTOR 1  
VECTOR 1  
VECTOR 1  
VECTOR 1  
VECTOR 1

No. 601



VECTOR 3  
VECTOR 3  
VECTOR 3  
VECTOR 3  
VECTOR 3

No. 602



VECTOR 5  
VECTOR 5  
VECTOR 5  
VECTOR 5  
VECTOR 5

No. 603











VECTOR 9  
VECTOR 9  
VECTOR 9  
VECTOR 9  
VECTOR 9

No. 604





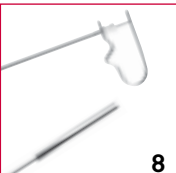

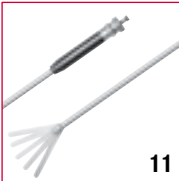

Zubehör  
Accessories  
Accessoires  
Accesorios  
Accessori

No. 610

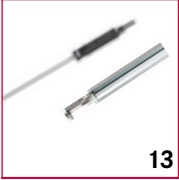
 1	<b>Laparoskope</b> <i>Laparoscopes</i> Laparoscopes <i>Laparoscopios</i> Laparoscopi	8
 2	<b>Trokare</b> <i>Trocars</i> Trocarts <i>Trócares</i> Trocar	12
 3	<b>Zusatzinstrumente und Insufflationskanülen</b> <i>Additional instruments and insufflation needles</i> Instruments additionnels et aiguilles d'insufflation <i>Instrumentos adicionales y agujas de insuflación</i> Strumenti addizionali e aghi d'insufflazione	25
 4	<b>Saug- und Spülkanülen</b> <i>Suction and irrigation cannulas</i> Canules d'irrigation et aspiration <i>Cánulas de irrigación y aspiración</i> Cannule per aspirazione ed irrigazione	27
 5	<b>Saug- und Spülsysteme / Monopolare Elektroden</b> <i>Suction and irrigation system / Monopolar electrodes</i> Système d'aspiration et irrigation / Electrodes monopolaires <i>Sistema de aspiración y irrigación / Electrodo monopoloares</i> Sistema aspirazione ed irrigazione / Elettrodi monopolari	30
 6	<b>Tekno Line Instrumente</b> <i>Tekno Line instruments</i> Instruments Tekno line <i>Instrumentos Tekno line</i> Strumenti Tekno line	35
 7	<b>Bipolare Instrumente</b> <i>Bipolar instruments</i> Instruments bipolaires <i>Instrumentos bipolares</i> Strumenti bipolari	65
 8	<b>Knotenschieber &amp; Fasszangen</b> <i>Knotguides &amp; Grasping forceps</i> <i>Pousse-noeuds &amp; Pincas á saisir</i> Guía de ligaduras & <i>Pinzas de baarre</i> <i>Spingi-nodi &amp; Pinze da presa</i>	72
 9	<b>Nahtinstrumente &amp; Nadelhalter</b> <i>Closure instruments &amp; Needle holders</i> Instruments de suture & Porte-aiguilles <i>Instrumentos de sutura &amp; Porta-agujas</i> Strumenti per la sutura & Port'aghi	73

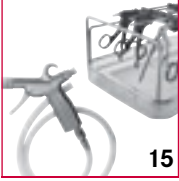
Inhalt | Contenu  
 Content | Indice  
 Indice

 <p>10</p>	<p><b>Clip Anlegezangen</b>  <i>Clip application forceps</i>                  Pinces à poser des clips                  Pinzas para clips                  Pinze per mettere clips</p>	79
 <p>11</p>	<p><b>Endoretraktoren</b>  <i>Endo-retractors</i>                  Endo-retracteurs                  Endo-retractores                  Endo-retrattori</p>	81
 <p>12</p>	<p><b>Monopolare Elektroden</b>  <i>Monopolar electrodes</i>                  Électrodes monopolaires                  Electrodes monopolares                  Elettrodi monopolari</p>	84
 <p>13</p>	<p><b>Bipolare Koagulationselektroden</b>  <i>Bipolar coagulation electrodes</i>                  Electrodes à coagulation bipolaire                  Electrodoos para la coagulación bipolar                  Elettrodi per coagulazione bipolare</p>	87
 <p>14</p>	<p><b>Ring Applikatoren, Uterusmanipulator &amp; Instrumente</b>  <i>Ring applicators, Uterus manipulator &amp; Instruments</i>                  Appicateurs des anneaux, Manipulator utérin &amp; Instruments                  Aplicadores de anillos, Manipulador uterino &amp; Instrumentos                  Applicatore per anelli, Manipolatore uterino &amp; Strumenti</p>	89
 <p>15</p>	<p><b>Reinigungs- und Sterilisationszubehör</b>  <i>Cleaning and sterilizing accessories</i>                  Accessoires pour nettoyage et stérilisation                  Accesorios para limpieza y esterilización                  Accessori per pulizia e sterilizzazione</p>	92
 <p>16</p>	<p><b>Ersatzteile, Pflegemittel</b>  <i>Spare parts, detergent for instruments</i>                  Pièces de réchange, détergents                  Piezas de recambio, detergentes                  Pezzi di ricambio, detergenti</p>	94
<p>tk 775-40                  tk 704-360                  17</p>	<p><b>Nummernverzeichnis</b>  <i>Numerical index</i>                  Index numérique                  Indice numerico                  Indice dei numeri d'articolo</p>	96



## Hochauflösende Endoskope *High definition endoscopes*

---

Endoscopes de haute définition  
*Endoscopios de alta definición*  
Endoscopi ad alta definizione

Unsere Endoskope zeichnen sich durch ein speziell berechnetes Linsensystem aus, welches optimal auf die in HD und 4K Kameras verwendeten Sensor Formate abgestimmt ist. Diese Optimierung überzeugt im Einsatz durch ein brillantes, klares Bild. Unsere neue Optiken-Linie "ULTRA-SHARP" besticht darüber hinaus durch eine außergewöhnliche Schärfe im Randbereich des Bildes.

*Our endoscopes stand out for their especially designed lens system, which is optimized for the sensor formats, used in HD and 4K cameras. This improvement convinces during use by a brilliant clear image. Our optics line "ULTRA SHARP" also impresses with its extraordinary sharpness at the edge of the image.*

Nos endoscopes se distinguent par leur système de lentilles, spécialement évalué et optimisé pour des formats des capteurs des caméras HD et 4K. Cette amélioration convainc pendant l'utilisation par un image brillant et clair. Notre ligne optique «ULTRA SHARP» impressionne également par son extraordinaire netteté au bord de l'image.

*Nuestros endoscopios se caracterizan por su sistema de lentes, especialmente evaluado y optimado para los formatos de los sensores en las cámaras HD y 4K. Este mejoración convence durante la utilización por un imagen brillante y claro. Nuestra línea óptica "ULTRA SHARP" también impresiona por su extraordinaria nitidez en el borde de la imagen.*

I nostri endoscopi si caratterizzano per il loro sistema di lenti, che è ottimizzato per il formato del sensore utilizzato nelle telecamere HD e 4K. I miglioramenti permettono di ottenere durante l'utilizzo un'immagine nitida e chiara. La nostra linea ottica "ULTRA SHARP" impressiona anche per la sua straordinaria definizione ai bordi dell'immagine.

## Kompatibilität *Compatibility*

---

Compatibilité  
*Compatibilidad*  
Compatibilità

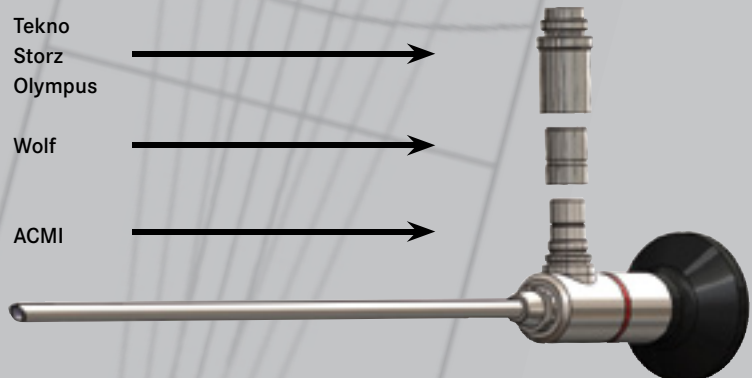



## Spezielle Eigenschaften

Aufgrund unserer langjährigen Erfahrung erfüllen unsere Optiken alle Voraussetzungen für ein qualitativ hochwertiges Produkt:

- **Kompakt-Objektive**  
Die in unseren Endoskopen verwendete neue Generation von Kompakt-Objektiven bietet die Gewähr für volle Autoklavierbarkeit, auch über einen langen Zeitraum hinweg und gibt damit dem Anwender die Sicherheit für eine lange Lebensdauer des Produktes.
- **Stablinsen-System**  
Neuberechnete Stablinsen-Systeme garantieren eine nicht zu übertreffende Bildhelligkeit
- **Großbildoptik**  
Eine hohe Vergrößerung garantiert dem Anwender ein angenehmes Arbeiten, auch wenn sich der Monitor nicht direkt am Operationsfeld befindet
- **Distal und proximal Saphirgläser**
- **Anwendungsbezogene Blickwinkel bei allen Optiken**
- **Exzellente Brillanz und Auflösung**
- **Natürliche Farbwiedergabe bei gleichmäßiger Bildschärfe**
- **Optimale Tiefenschärfe, ebenfalls ausgerichtet an den Erfordernissen des Einsatzgebietes**

## Qualités particulières

A cause de notre longue expérience, nos optiques répondent à toutes exigences pour des produits de haute gamme

- **objectif compact**  
la nouvelle génération des objectifs utilisés dans nos endoscopes garantie que les produits peuvent être autoclavés, même pendant une très longue période, et donne à l'utilisateur la sécurité pour une longue vie du produit.
- **système des lentilles en tiges**  
ce système, nouvellement évalué, garantit la meilleure clarté de l'image
- **grandeur de l'image**  
le grossissement le plus grand possible garantit un travail agréable pour l'utilisateur, surtout quand l'écran ne se trouve pas à coté de l'opérateur.
- **différents angles, selon les besoins du travail**
- **illumination brillante et très haute résolution**
- **reproduction des couleurs naturelles en netteté constante de l'image**
- **profondeur de champ optimale, selon les nécessités de l'opération**



**Kompakt-Objektiv**  
*Compact objective*  
Objectif compact  
*Objectivos compactos*  
Obiettivi compatti

## Particular attributes

*Due to our long experience, our scopes meet all technical requirements of a first class product:*

- *compact objectives*  
*the new generation of compact objectives used in our endoscopes provides the guarantee of full autoclavability even for a long period and gives the user the security of a long life of the product.*
- *rod lens system*  
*the new evaluated rod lens systems guarantees an illumination which really is second to none*
- *large image size*  
*a high enlargement guarantees a comfortable working, even if the monitor is not so close to the operation field*
- *distal and proximal saphire windows*
- *comfortable direction of view on all scopes according to the necessity of the operation*
- *brilliant illumination and crystal clear resolution*
- *true colour reflection and regular focus on the whole image*
- *optimal depth of field, also according to the necessity of the operation*

## Características particulares

*En base a nuestra larga experiencia, nuestras ópticas satisfacen todas las normas de los productos de alta calidad.*

- *objetivos compactos*  
*la nueva generación de objetivos, incorporados en nuestras ópticas, ofrece la garantía de esterilización por autoclave durante un largo periodo de tiempo y da de durabilidad al producto.*
- *sistema de lentes a varillas*  
*este nuevo sistema garantiza la mejor luminosidad de la imagen.*
- *dimensión de la imagen*  
*el aumento de la dimensión de la imagen, garantiza un trabajo agradable, aunque el monitor está posicionado lejos de la mesa.*
- *diferentes ángulos visuales según las necesidades de trabajo*
- *iluminación brillante y una resolución muy alta*
- *reproducción de los colores naturales a una nitidez constante de la imagen*
- *profundidad del campo según las necesidades de trabajo*

## Caratteristiche particolari

Grazie alla nostra lunga esperienza, i nostri endoscopi presentano tutte le caratteristiche dei prodotti di alto livello:

- **obiettivi compatti:** la nuova generazione di obiettivi compatti usata nei nostri endoscopi garantisce la totale autoclavabilità anche per un lungo periodo e dà all'utilizzatore la certezza di una lunga durata del prodotto
- **sistema rod lens:** la nuova generazione del sistema di rod lens assicura una illuminazione che non è seconda a nessun altro prodotto
- **immagini di grandi dimensioni:** un elevato fattore di ingrandimento permette un lavoro confortabile, anche se il monitor non è vicino all'operatore
- **lenti prossimali e distali in zaffiro**
- **angolo di visione perfetto, specifico per ogni campo di utilizzo**
- **illuminazione brillante e risoluzione cristallina**
- **trasmissione dei colori reale, e immagine perfettamente a fuoco su tutto il campo**
- **profondità di campo ottimale, studiata per le necessità dei diversi campi di utilizzo**

Laparoskope  
Laparoscopes  
Laparoscopes  
Laparoscopi

autoklavierbar / autoclavable  
134°C / 273°F - 18 min.

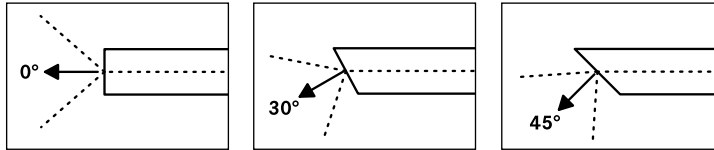

Ø 5.0 mm - 240 mm	tk 700-001	tk 700-011	-
Ø 5.0 mm - 300 mm	tk 700-000	tk 700-003	tk 700-004
Ø 5.0 mm - 360 mm	tk 700-002	tk 700-012	-
Ø 10.0 mm - 310 mm	tk 700-020	tk 700-023	tk 700-024
Ø 10.0 mm - 450 mm	tk 700-420	tk 700-423	tk 700-424
Ø 10.0 mm - 540 mm	tk 700-430	tk 700-433	-

**FULL SCREEN**

Ø 5.5 mm - 310 mm	tk 700-450	tk 700-453	-
-------------------	------------	------------	---



**ULTRA SHARP**

Ø 5.5 mm - 300 mm	tk 700-300	tk 700-301	tk 700-302
Ø 10.0 mm - 330 mm	tk 700-028	tk 700-029	-
Ø 10.0 mm - 450 mm	tk 700-310	tk 700-311	tk 700-312

Ø, Arbeitslänge  
Ø, Working length  
Ø, Longueur de travail  
Ø, Longitud de trabajo  
Ø, Lunghezza operativa

**Mini-Laparoskope**  
*Mini laparoscopes*

Mini laparoscopes  
*Mini laparoscopios*  
Mini laparoscopi

autoklavierbar / autoclavable  
134°C / 273°F - 18 min.

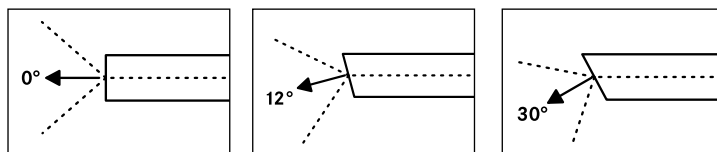

Ø 2.7 mm - 270 mm	<b>tk 700-275</b>	-	<b>tk 700-276</b>
Ø 3.0 mm - 300 mm	<b>tk 700-204</b>	<b>tk 700-205</b>	<b>tk 700-203</b>
Ø 4.0 mm - 200 mm	<b>tk 700-030</b>	-	<b>tk 700-033</b>

Ø 2.7 mm - 270 mm	<b>tk 700-275SF</b>	-	<b>tk 700-276SF</b>
-------------------	---------------------	---	---------------------

Ø, Arbeitslänge

Ø, Working length

Ø, Longueur de travail

Ø, Longitud de trabajo

Ø, Lunghezza operativa

SF = Tekno-Flex

**OP - Laparoscope**  
*OP - Laparoscopes*

**OP - Laparoscopes**  
*OP - Laparoscopios*  
Laparoscopi operativi

OP - Laparoskop mit integriertem Instrumentenkanal, 0° Weitwinkel, Paralleleinblick  
*OP - Laparoscope with integrated instrument channel, 0° wide angle, parallel view*

OP - Laparoscope avec canal d'instruments incorporé, 0° grand angle, vision parallèle  
*OP - Laparoscopio con canal incorporado para instrumentos, 0° gran ángulo, vista paralela*  
Laparoscopio operativo con canale di lavoro, 0° grandangolo, oculare parallela

autoklavierbar / autoclavable  
134°C / 273°F 18 min.

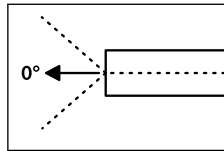
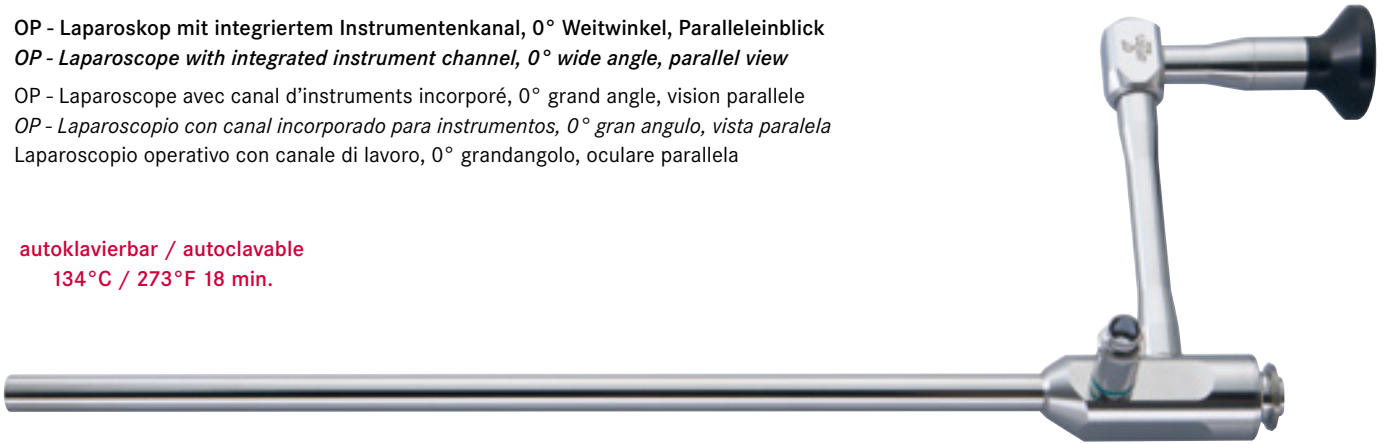

Ø 10.0 mm - 268 mm	Ø 6.0 mm	<b>tk 700-250</b>
Ø, Arbeitslänge Ø, Working length	Instrumentenkanal Instrument channel	inkl. Adapter incl. adapter
Ø, Longueur de travail Ø, Longitud de trabajo	Canal d'instrument Canal para instrumentos	incl. adaptateur adaptador incluido
Ø, Lunghezza operativa	Canale operativo	adattore incluso

**tk 700-255**

Adapter  
Adapter  
Adaptateur  
Adaptador  
Adattatore

OP - Laparoskop mit integriertem Instrumentenkanal, 0° Weitwinkel, Lateraleinblick  
*OP - Laparoscope with integrated instrument channel, 0° wide angle, lateral view*

OP - Laparoscope avec canal d'instruments incorporé, 0° grand angle, vision latéral  
*OP - Laparoscopio con canal incorporado para instrumentos, 0° gran ángulo, vista lateral*  
Laparoscopio operativo con canale di lavoro, 0° grandangolo, oculare angolato

autoklavierbar / autoclavable  
134°C / 273°F

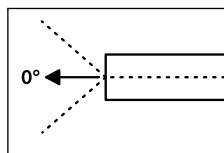
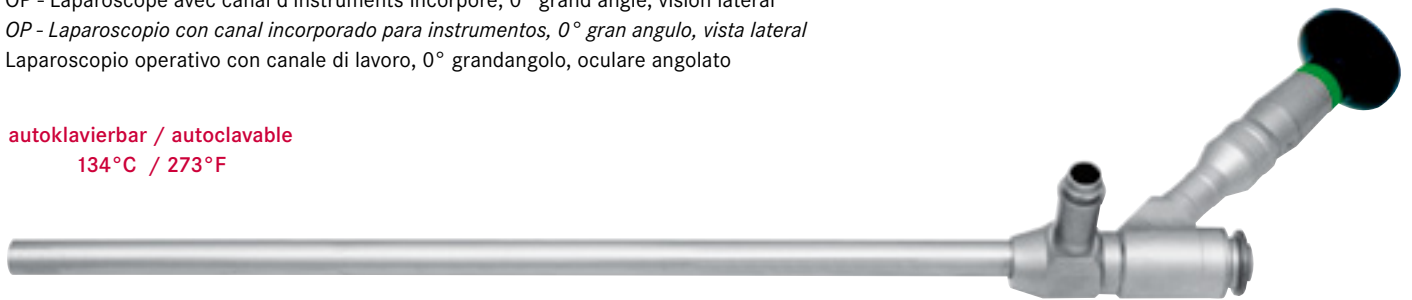

Ø 10.0 mm - 268 mm	Ø 6.0 mm	<b>tk 700-251</b>
Ø, Arbeitslänge Ø, Working length	Instrumentenkanal Instrument channel	inkl. Adapter incl. adapter
Ø, Longueur de travail Ø, Longitud de trabajo	Canal d'instrument Canal para instrumentos	incl. adaptateur adaptador incluido
Ø, Lunghezza operativa	Canale operativo	adattore incluso

**tk 700-256**

Adapter  
Adapter  
Adaptateur  
Adaptador  
Adattatore

Haltearm für Optiken  
*Holding arm for scopes*

Support pour endoscopes  
*Soporte para endoscopios*  
Supporto per endoscopi



**tk 700-990**

Haltearm für Optiken (Ø 5 + 10mm)

*Holding arm for scopes (Ø 5 + 10mm)*

Support pour endoscopes (Ø 5 + 10mm)

*Soporte para endoscopios (Ø 5 + 10mm)*

Supporto per endoscopi (Ø 5 + 10mm)

## Trokare Trocars

Trocarts  
Trócares  
Trocar

### LIGHTWEIGHT-LINE

LIGHTWEIGHT **LW**

- Ultra-leichtgewicht durch Kunststoff-Grundkörper
- Wiederverwendbare Silikondichtung
- Erhältlich in:  $\varnothing$  5,5mm und  $\varnothing$  11,0mm
- *Ultra lightweight plastic body*
- *Reusable silicone valve*
- *Available in:  $\varnothing$  5.5mm and  $\varnothing$  11.0mm*
- Tête ultra-légère en matière plastique
- Valve en silicon, réutilisable
- Disponible en:  $\varnothing$  5,5mm et  $\varnothing$  11,0mm
- *Cuerpo ultraligero de plastica*
- *Valvula de silicona, reutilisable*
- *Disponibile en:  $\varnothing$  5,5mm y  $\varnothing$  11,0mm*
- Molto leggera grazie al corpo di plastica
- Valvola di silicone riutilizzabile
- Fornibile nelle grandezze:  $\varnothing$  5,5mm e  $\varnothing$  11,0mm

**LW**

### SLIM-LINE

SLIM **SL**

- Bis zu 25% Gewichtsersparnis gegenüber der Classic-Line
- Farbkennzeichnung an Schaft und Grundkörper
- Erhältlich in:  $\varnothing$  5,5mm und  $\varnothing$  11,0mm und  $\varnothing$  13,0mm
- *Up to 25% saving on weight compared with Classic-Line*
- *Colour coding at sheath and body*
- *Available in:  $\varnothing$  5.5mm,  $\varnothing$  11.0mm and  $\varnothing$  13.0mm*
- Jusqu'à 25% de réduction de poids par rapport à la CLASSIC-LINE
- Codage par couleurs sur le tube et le corps
- Disponible en :  $\varnothing$  5,5 mm,  $\varnothing$  11,0 mm et  $\varnothing$  13,0 mm
- *Hasta un 25% de reducción de peso en comparación con la CLASSIC-LINE*
- *Codificación de colores en el tubo y en el cuerpo*
- *Disponibile en:  $\varnothing$  5,5mm,  $\varnothing$  11,0mm y  $\varnothing$  13,0mm*
- Riduzione del peso fino al 25% rispetto a CLASSIC-LINE
- Codificazione a colori su tubo e corpo
- Disponibile in:  $\varnothing$  5,5 mm,  $\varnothing$  11,0 mm e  $\varnothing$  13,0 mm

**SL**

### CLASSIC-LINE

CLASSIC **CL**

- Leichte Handhabung
- Jahrzehnte bewährtes Standard-Modell
- Erhältlich in:  $\varnothing$  3,5mm,  $\varnothing$  5,5mm,  $\varnothing$  7,0mm,  $\varnothing$  11,0mm,  $\varnothing$  15,0mm und  $\varnothing$  20,0mm
- *Easy handling*
- *Since decades proven standard model*
- *Available in:  $\varnothing$  3.5mm,  $\varnothing$  5.5mm,  $\varnothing$  7.0mm,  $\varnothing$  11.0mm,  $\varnothing$  15.0mm and  $\varnothing$  20.0mm*
- Manipulation facile
- Modèle standard éprouvé depuis décennies
- Disponible en :  $\varnothing$  3,5 mm,  $\varnothing$  5,5 mm,  $\varnothing$  7,0 mm,  $\varnothing$  11,0 mm,  $\varnothing$  15,0 mm et  $\varnothing$  20,0 mm
- *Fácil manejo*
- *Modelo estándar probado desde décadas*
- *Disponibile en:  $\varnothing$  3.5mm,  $\varnothing$  5.5mm,  $\varnothing$  7.0mm,  $\varnothing$  11.0mm,  $\varnothing$  15.0mm y  $\varnothing$  20.0mm*
- Semplice manipolazione
- Modello standard provato da decenni
- Disponibile in:  $\varnothing$  3.5mm,  $\varnothing$  5.5mm,  $\varnothing$  7.0mm,  $\varnothing$  11.0mm,  $\varnothing$  15.0mm e  $\varnothing$  20.0mm

**CL**



**Trokare** | Trocars  
**Trocars** | Trócares  
 Trocar

Trokarhülse, allein  
*Trocar sleeve, only*  
 Gaine de trocart, seule  
*Vaina de trocar, sola*  
 Camicia, sola



	x = 60 mm	x = 100 mm
Ø 2.9 mm	<b>tk 730-170</b>	<b>tk 730-160</b>
	Metallrohr, glatt <i>Metal tube, smooth</i>	Metallrohr, glatt <i>Metal tube, smooth</i>
	Tube metalique, lisse <i>Tubo de metal, lisa</i>	Tube metalique, lisse <i>Tubo de metal, lisa</i>
	Tubo metallico, liscio	Tubo metallico, liscio



Trokare | Trocarts  
Trocars | Trócares  
Trocar

*Leichtgewicht Trokarhülse mit Valve und Hahn*

*Lightweight trocar sheath with valve and stopcock*

*Gaine de trocart légères avec valve en silicone et robinet*

*Vaina de trocar ligeros con valvula y robinete*

*Camicia leggera con valvola e rubinetto*

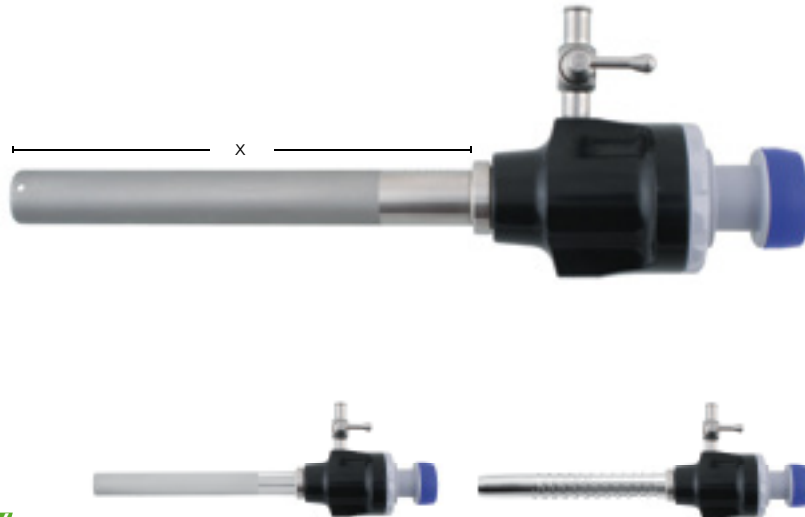

**LIGHTWEIGHT** 

Ø 5.5 mm	x = 95 mm	<b>tk 704-687</b>	<b>tk 704-688</b>
Ø 11.0 mm	x = 105 mm	<b>tk 704-691</b>	<b>tk 704-692</b>

Metallrohr, glatt  
*Metal tube, smooth*  
Tube metalique, lisse  
*Tubo de metal, lisa*  
Tubo metallico, liscio

Metallrohr mit Gewinde  
*Metal tube, threaded*  
Tube metalique avec filetage  
*Tubo de metal con rosco*  
Tubo metallico con filetto

**LIGHTWEIGHT** 

Ø 5.5 mm	x = 95 mm	<b>tk 704-689</b>	<b>tk 704-690</b>
Ø 11.0 mm	x = 101 mm	<b>tk 704-693</b>	<b>tk 704-694</b>

Kunststoffrohr, glatt  
*Plastic tube, smooth*  
Tube plastique, lisse  
*Tubo plastico, lisa*  
Tubo di plastica, liscia

Kunststoffrohr mit Gewinde  
*Plastic tube, threaded*  
Tube plastique avec filetage  
*Tubo de plastico con rosca*  
Tubo di plastica con filetto

Trokare  
Trocars  
Trocarts  
Trócares  
Trocar

Trokarhülse mit Automatik-Ventil, manueller Klappenöffnung und Hahn  
*Trocar sheath with multifunctional valve and stopcock*

Gaine de trocar avec valve automatique, ouverture manuelle et robinet  
*Vaina de trocar con valvula automatica, apertura manual y robinete*  
*Camicia con valvola automatica con leva apriporta e rubinetto*

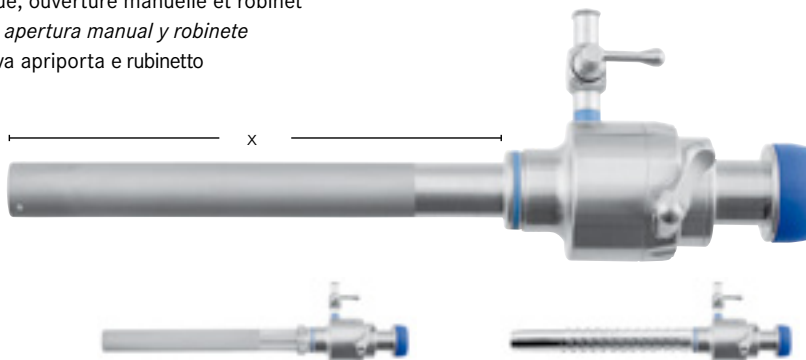

SLIMSLI

Ø 5.5 mm ○	x = 103 mm	tk 704-360	tk 704-670
Ø 11.0 mm ●	x = 105 mm	tk 704-365	tk 704-673
Ø 13.0 mm ●	x = 102 mm	tk 704-295	tk 704-676

Metallrohr, glatt  
*Metal tube, smooth*  
Tube metalique, lisse  
*Tubo de metal, lisa*  
Tubo metallico, liscio

Metallrohr mit Gewinde  
*Metal tube, threaded*  
Tube metalique avec filetage  
*Tubo de metal con rosca*  
Tubo metallico con filetto



SLIMSLI

Ø 5.5 mm ○	x = 95 mm	tk 704-671	tk 704-672
Ø 11.0 mm ●	x = 97 mm	tk 704-674	tk 704-675
Ø 13.0 mm ●	x = 94 mm	tk 704-677	tk 704-678

Kunststoffrohr, glatt  
*Plastic tube, smooth*  
Tube plastique, lisse  
*Tubo plastico, lisa*  
Tubo di plastica, liscia

Kunststoffrohr mit Gewinde  
*Plastic tube, threaded*  
Tube plastique avec filetage  
*Tubo de plastico con rosca*  
Tubo di plastica con filetto

SLIMSLI-XL

Ø 5.5 mm ○	x = 150 mm	tk 704-4002-15
Ø 11.0 mm ●	x = 150 mm	tk 704-4010-15
Ø 13.0 mm ●	x = 150 mm	tk 704-4012-15

Metallrohr, glatt  
*Metal tube, smooth*  
Tube metalique, lisse  
*Tubo de metal, lisa*  
Tubo metallico, liscio



Trokare | Trocarts  
Trocars | Trócares  
Trocar

High Flow Trokarhülse mit Automatik-Ventil, manueller Klappenöffnung und Hahn  
*High Flow trocar sheath with multifunctional valve and stopcock*

High Flow gaine de trocar avec valve automatique, ouverture manuelle et robinet

*High Flow vaina de trócar con valvula automatic, aperatura manual y robinete*

High Flow camicia con valvola automatic con leva aprivalvola e rubinetto

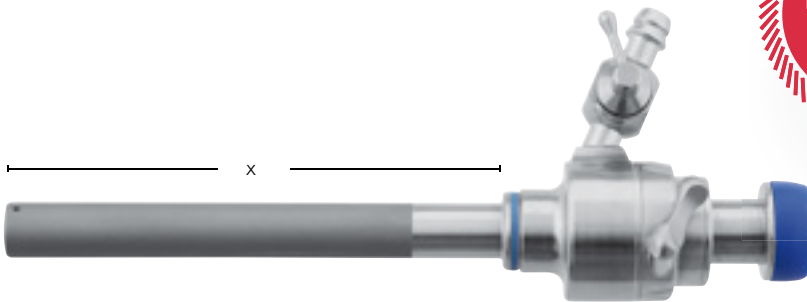

**SLIM**

Ø 11.0 mm ● x = 105 mm

**tk 704-308**

Metallrohr, glatt

*Metal tube, smooth*

Tube metalique, lisse

*Tubo de metal, lisa*

Tubo metallico, liscio

Trokare  
Trocars

Trocarts  
Trócares  
Trocar

Trokarhülse mit Automatik-Ventil, manueller Klappenöffnung und Hahn  
*Trocar sheath with multifunctional valve and stopcock*

Gaine de trocar avec valve automatique, ouverture manuelle et robinet

Vaina de trocar con valvula automatica, apertura manual y robinete

Camicie con valvola automatica con leva aprivalvola e rubinetto

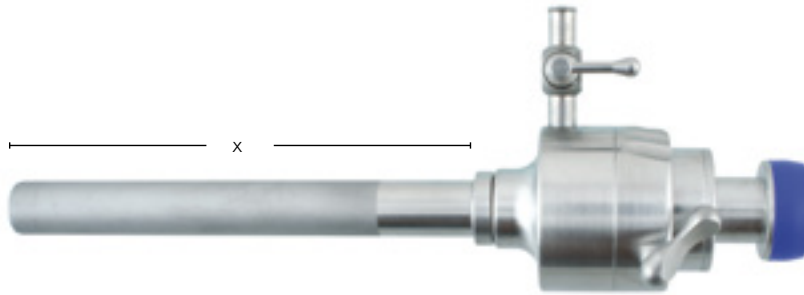

CLASSIC

Ø 3.5 mm	x = 70 mm	tk 730-210	-
Ø 5.5 mm	x = 95 mm	tk 704-679	tk 704-680
Ø 7.0 mm	x = 95 mm	tk 704-362	-
Ø 11.0 mm	x = 101 mm	tk 704-683	tk 704-684

Metallrohr, glatt  
*Metal tube, smooth*  
Tube metalique, lisse  
*Tubo de metal, lisa*  
Tubo metallico, liscio

Metallrohr mit Gewinde  
*Metal tube, threaded*  
Tube metalique avec filetage  
*Tubo de metal con rosco*  
Tubo metallico con filetto



CLASSIC

Ø 5.5 mm	x = 95 mm	tk 704-681	tk 704-682
Ø 11.0 mm	x = 101 mm	tk 704-685	tk 704-686

Kunststoffrohr, glatt  
*Plastic tube, smooth*  
Tube plastique, lisse  
*Tubo plastico, lisa*  
Tubo di plastica, liscia

Kunststoffrohr mit Gewinde  
*Plastic tube, threaded*  
Tube plastique avec filetage  
*Tubo de plastico con rosca*  
Tubo di plastica con filetto

Trokare | Trocarts  
 Trocars | Trócares  
 Trocar

Trokarhülse mit Automatik-Ventil, manueller Klappenöffnung und Hahn  
*Trocar sheath with multifunctional valve and stopcock*

Gaine de trocart avec valve automatique, ouverture manuelle et robinet

Vaina de trócar con valvula automatica, apertura manual y robinete

Camicia con valvola automatica con leva aprivalvola e rubinetto

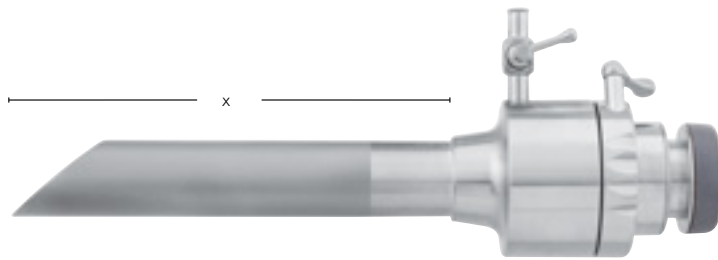

**CLASSIC** 

Ø 15.0 mm	x = 110 mm	<b>tk 704-367</b>
Ø 20.0 mm	x = 119 mm	<b>tk 704-368</b>

**Metallrohr glatt, nicht abnehmbar**  
***Metal tube smooth, not removable***

Tube metalique lisse, non démontables

*Tubo de metal lisa, no desmontables*

Tubo metallico liscio, non smontabile

Trokare | Trocarts  
 Trocars | Trócares  
 Trocar

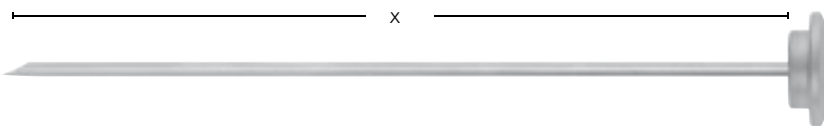

Ø 2.8 mm	x = 108 mm	x = 148 mm
	<b>tk 730-171</b>	<b>tk 730-161</b>
	<b>tk 730-172</b>	<b>tk 730-162</b>

für tk 730-170  
 for tk 730-170  
 pour tk 730-170  
 para tk 730-170  
 per tk 730-170

für tk 730-160  
 for tk 730-160  
 pour tk 730-160  
 para tk 730-160  
 per tk 730-160



Ø 3.5 mm		<b>tk 704-070</b>	<b>tk 730-220</b>	<b>tk 704-072</b>
Ø 5.5 mm		<b>tk 704-016</b>	<b>tk 704-022</b>	<b>tk 704-031</b>
Ø 7.0 mm		<b>tk 704-014</b>	<b>tk 704-018</b>	-
Ø 10.0 mm		-	-	<b>tk 704-033</b>
Ø 11.0 mm		<b>tk 704-006</b>	<b>tk 704-026</b>	<b>tk 704-035</b>
Ø 12.5 mm		-	-	<b>tk 704-036</b>
Ø 13.0 mm		<b>tk 704-093</b>	<b>tk 704-092</b>	-
Ø 15.0 mm		<b>tk 704-015</b>	<b>tk 704-028</b>	-
Ø 20.0 mm		<b>tk 704-020</b>	<b>tk 704-029</b>	-

Ø 5.5 mm		<b>tk 704-016-15</b>	<b>tk 704-022-15</b>	-
Ø 11.0 mm		<b>tk 704-006-15</b>	<b>tk 704-026-15</b>	-
Ø 13.0 mm		<b>tk 704-012-15</b>	<b>tk 704-027-15</b>	-

Für Trokar-System  
 For trocar system  
 Pour système trocar  
 Para el sistema de trócares  
 Sistema per trocar

Trokar (dreikant)  
 Trocar (pyramidal)  
 Trocart (pyramidal)  
 Trócar (piramidal)  
 Trocar (piramidale)

Trokar (Kegelform)  
 Trokar (conical tip)  
 Trocart (conique)  
 Trócar (conico)  
 Trocar (conico)

Trokar (stumpf)  
 Trocar (blunt)  
 Trocart (mousse)  
 Trócar (romo)  
 Trocar (smusso)

Sicherheitstrokare  
Safety trocars

Trocarts de sécurité  
Trócares de seguridad  
Trocars di sicurezza



Ø 3.5 mm	x = 132 mm	<b>tk 704-090</b>
----------	------------	-------------------

Sicherheitstroker, demontierbar  
Safety trocar, detachable

Trocart de sécurité, démontable  
Trócar de seguridad, desmontable  
Trocar di sicurezza, smontabile



Ø 5.5 mm	<b>AW SL CL</b>	<b>tk 704-087</b>	<b>tk 704-060</b>	<b>tk 704-065</b>
Ø 5.5 mm	<b>SL-XL</b>	-	-	<b>tk 704-076</b>
Ø 11.0 mm	<b>AW SL CL</b>	<b>tk 704-088</b>	<b>tk 704-061</b>	<b>tk 704-067</b>
Ø 11.0 mm	<b>SL-XL</b>	-	-	<b>tk 704-077</b>
Ø 13.0 mm	<b>SL</b>	<b>tk 704-160</b>	<b>tk 704-161</b>	<b>tk 704-162</b>
Ø 13.0 mm	<b>SL-XL</b>	-	-	<b>tk 704-078</b>

Für Trokar-System  
For trocar system

Pour système trocar  
Para el sistema de trócares  
Sistema per trocar

Messerform  
Knife shape

Forme de couteau  
Forme de cuchillo  
Forma a coltello

schräg  
oblique

obliques  
oblicuos  
taglio inclinato

dreikant  
pyramidal

pyramidales  
piramidales  
piramidale



**Zubehör für Trokare**  
**Accessories for trocars**

Accessoires pour trocarts  
Accesorios para trócares  
Accessorio per trocar



	35.0 mm
Ø 5.5 mm	<b>tk 704-436</b>
Ø 10.0 mm	<b>tk 704-437</b>
Ø 11.0 mm	<b>tk 704-438</b>
Ø 12.5 mm	<b>tk 704-439</b>
Ø 13.0 mm	<b>tk 704-440</b>

- Ø Trokar **Abstandshalter mit Fixiergewinde**
- Ø Trocar **Distance holder with fixation thread**
- Ø Trocart Pièce de distance avec vis de fixation
- Ø Trócar **Pieza de distancia con tornillo de fijación**
- Ø Trocar **Distanziatore con vite di fissaggio**



Ø 5.5 mm	Ø 3.0 mm	<b>tk 704-233</b>
Ø 10.0 mm	Ø 5.5 mm	<b>tk 704-240</b>
Ø 11.0 mm	Ø 5.5 mm	<b>tk 704-241</b>
Ø 12.5 mm	Ø 5.5 mm	<b>tk 704-242</b>
Ø 12.5 mm	Ø 10.0 mm	<b>tk 704-243</b>
Ø 13.0 mm	Ø 5.5 mm	<b>tk 704-244</b>
Ø 13.0 mm	Ø 10.0 mm	<b>tk 704-245</b>

- Ø Trokar **Reduzieraufsatz mit Silikonhalterung**
- Ø Trocar **Reduction adaptors with silicon-holder**
- Ø Trocart Réducteur avec support de silicón
- Ø Trócar **Reductor con soporte de silicona**
- Ø Trocar **Riduttore con supporto in silicone**



Ø 5.0 mm	Ø 4.0 mm	<b>tk 704-200</b>
Ø 11.0/10.0 mm	Ø 5.5 mm	<b>tk 704-000</b>
Ø 12.5 mm	Ø 5.5 mm	<b>tk 704-216</b>
Ø 15.0 mm	Ø 5.5 mm	<b>tk 704-203</b>
Ø 12.5 mm	Ø 10.0 mm	<b>tk 704-217</b>
Ø 15.0 mm	Ø 10.0 mm	<b>tk 704-204</b>
Ø 20.0 mm	Ø 10.0 mm	<b>tk 704-207</b>
Ø 20.0 mm	Ø 15.0 mm	<b>tk 704-218</b>

- Ø Trokar **Reduzierhülsen**
- Ø Trocar **Reduction sleeves**
- Ø Trocart Gaine de réduction
- Ø Trócar **Vaina para reducción**
- Ø Trocar **Riduttore**

Zubehör für Trokare  
Accessories for trocars

Accessoires pour trocars  
Accesorios para trócares  
Accessorio per trocar



Ø 3.5 mm	<b>tk 704-395 K</b>
Ø 5.5 mm	<b>tk 704-397 K</b>
Ø 10.0 mm	<b>tk 704-398 K</b>
Ø 11.0 mm	<b>tk 704-399 K</b>
Ø 12.5 mm	<b>tk 704-389 K</b>
Ø 13.0 mm	<b>tk 704-390 K</b>

Ø Trokar **Hassonkonus fixierbar mit Fadenhaltern**  
 Ø Trocar **Hassoncone fixable with suture holder**  
 Ø Trocart **Conus de Hasson à fixer, avec porte-fils**  
 Ø Trócar **Cono de Hasson fijable, con porta suturas**  
 Ø Trocar **Cono di Hasson con levette porta sutura**



Ø 3.5 mm	<b>tk 704-0022</b>	●
Ø 5.5 mm	<b>tk 704-0023</b>	●
Ø 10.0 mm	<b>tk 704-0024</b>	●
Ø 11.0 mm	<b>tk 704-0025</b>	●
Ø 12.5 mm	<b>tk 704-0026</b>	●
Ø 13.0 mm	<b>tk 704-0027</b>	●

Ø Trokar **Dichtkappe (Farbe), Pack mit 10 Stück**  
 Ø Trocar **Sealing cap (colour), pack of 10 pieces**  
 Ø Trocart **Capuchon (couleur), paquet de 10 pièces**  
 Ø Trócar **Capuchón (color), paquetes de 10 piezas**  
 Ø Trocar **Cappuccio (colore), conf. da 10 pezzi**



Ø 10.0 mm	Ø 5.5 mm	<b>tk 704-235</b>
Ø 11.0 mm	Ø 5.5 mm	
Ø 11.0 mm	Ø 10.0 mm	
Ø 12.5 mm	Ø 5.5 mm	
Ø 13.0 mm	Ø 5.5 mm	
Ø 12.5 mm	Ø 10.0 mm	<b>tk 704-238</b>
Ø 13.0 mm	Ø 10.0 mm	

Ø Trokar **Schiebereducierer verwendbar für alle TEKNO Automatiktrocarhülsen**  
 Ø Trocar **Reduction piece for all TEKNO automatic trocars**  
 Ø Trocart **Réducteur pour tous les trocars automatiques de TEKNO**  
 Ø Trócar **Reductor para todos trócares automaticos de TEKNO**  
 Ø Trocar **Riduttore per tutti trocar automatici TEKNO**

Zubehör für Trokare  
Accessories for trocars

Accessoires pour trocarts  
Accesorios para trócares  
Accessorio per trocar

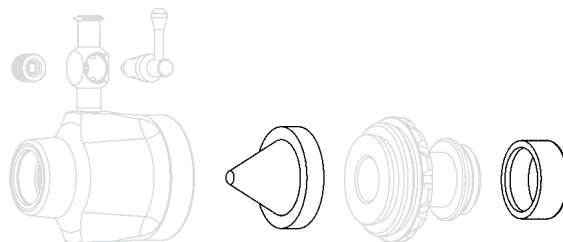

LIGHTWEIGHT LW

Packaging unit		5 Pcs.	10 Pcs.
Ø 5.5 mm	LW	tk 704-0020	tk 704-0004 ○
Ø 11.0 mm	LW	tk 704-0021	tk 704-0008 ●
Ø Trokar	Für Trokar-System	Silikonventil	Dichtkappe (Farbe)
Ø Trocar	For trocar system	Silicone valve	Sealing cap (colour)
Ø Trocart	Pour système trocar	Valve silicon	Capuchon (couleur)
Ø Trócar	Para el sistema de trócares	Valvula silicona	Capuchón (color)
Ø Trocar	Sistema per trocar	Valvola silicone	Cappuccio (colore)

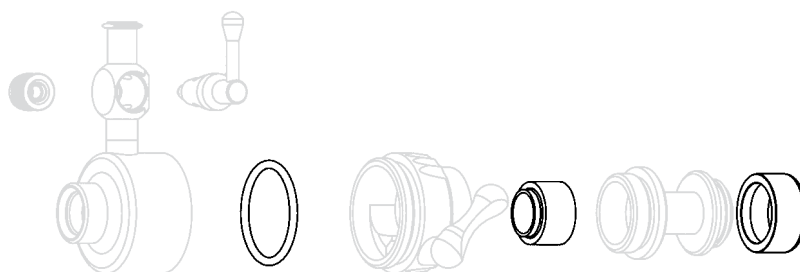

SLIM SL  
CLASSIC CL

Packaging unit		1 Pcs.	10 Pcs.	10 Pcs.
Ø 3.5 mm	CL	tk 704-0122	tk 704-0202 ●	tk 704-0002 ●
Ø 5.5 mm	CL	tk 704-0124	tk 704-0200A ●	tk 704-0004A ●
Ø 5.5 mm	SL	tk 704-0123	tk 704-0200 ○	tk 704-0004 ○
Ø 7.0 mm	CL	tk 704-0124	tk 704-0200A ●	tk 704-0006 ●
Ø 11.0 mm	CL	tk 704-0127	tk 704-0201A ●	tk 704-0008 ●
Ø 11.0 mm	SL	tk 704-0124	tk 704-0201 ●	tk 704-0008 ●
Ø 13.0 mm	SL	tk 704-0124	tk 704-0205 ●	tk 704-0010 ●
Ø 15.0 mm	CL	tk 704-0128	tk 704-0204 ●	tk 704-0013 ●
Ø 20.0 mm	CL	tk 704-0129	tk 704-0204 ●	tk 704-0018 ●
Ø Trokar	Für Trokar-System	O-Ring	Innendichtung (Farbe)	Dichtkappe (Farbe)
Ø Trocar	For trocar system	O ring	Inner sealing (colour)	Sealing cap (colour)
Ø Trocart	Pour système trocar	Anneau O	Jointe interne (couleur)	Capuchon (couleur)
Ø Trócar	Para el sistema de trócares	Anillo O	Guarnición interna (color)	Capuchón (color)
Ø Trocar	Sistema per trocar	O Ring	Guarnizione interna (colore)	Cappuccio (colore)

**Thoraxtrokare**  
*Thoracic trocars*

Trocarts thoraciques  
*Trócares torácicos*  
Trocar per torace

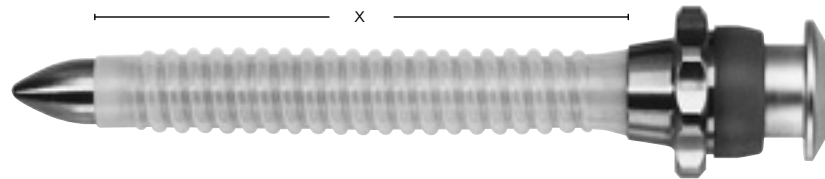

Ø 9.0 mm	Ø 6.0 mm	x = 100 mm	<b>tk 712-440</b>	<b>tk 712-441</b>	<b>tk 712-442</b>	<b>tk 712-443</b>
Ø 9.0 mm	Ø 6.0 mm	x = 70 mm	<b>tk 712-450</b>	<b>tk 712-451</b>	<b>tk 712-452</b>	<b>tk 712-453</b>
Ø 14.2 mm	Ø 11.0 mm	x = 100 mm	<b>tk 712-460</b>	<b>tk 712-461</b>	<b>tk 712-462</b>	<b>tk 712-463</b>
Ø 14.2 mm	Ø 11.0 mm	x = 70 mm	<b>tk 712-470</b>	<b>tk 712-471</b>	<b>tk 712-472</b>	<b>tk 712-473</b>

**Flexible Thoraxtrokare**  
*Flexible thoracic trocars*  
Trocarts thoraciques, flexibles  
*Trócares torácicos, flexibles*  
Trocar per torace, flessibile

**Komplett mit Obturator**  
*Complete with obturator*  
Complet avec obturateur  
Completo con oturador  
Completo con otturatore

**Trokarhülse allein**  
*Trocar sleeve only*  
Gaine seule  
Vaina sola  
Camicia sola

**Obturator allein**  
*Obturator only*  
Obturateur seul  
Obturador solo  
Otturatore solo

**Flexible Kunststoffrohre (5 Stck)**  
*Flexible plastic tubes (5 pcs.)*  
Gaines en plastique (5 pcs)  
*Vainas de plastica (5 pzas)*  
Tubi di plastica (5 pezzi)



Weitere Thorax-Instrumente finden Sie in unserem VATS Katalog  
*More thoracic instruments can be found in our VATS catalogue*

*Vous trouverez plus d'instruments thoraciques dans notre VATS catalogue*

*Más instrumentos torácicos en nuestro catálogo VATS*

Altri strumenti toracici si possono trovare nel nostro catalogo VATS

**Zusatzinstrumente**  
**Additional instruments**

Instruments additionnels  
*Instrumentos adicionales*  
Strumenti addizionali



Ø 5.0 mm	Ø 10.0 mm	<b>tk 704-220</b>
Ø 5.0 mm	Ø 11.0 mm	<b>tk 704-225</b>
Ø 5.0 mm	Ø 15.0 mm	<b>tk 704-221</b>
Ø 5.0 mm	Ø 20.0 mm	<b>tk 704-222</b>
Ø 10.0 mm	Ø 15.0 mm	<b>tk 704-223</b>
Ø 10.0 mm	Ø 20.0 mm	<b>tk 704-224</b>

Dilatations - Satz von Ø auf Ø  
*Dilatation - Set from Ø to Ø*  
 Jeu des dilateurs de Ø à Ø  
*Juego de dilatadores de Ø a Ø*  
 Dilatatori-Set da Ø a Ø



	Ø 2.8 mm	Ø 5.0 mm
250 mm	<b>tk 760-000-25</b>	-
300 mm	-	<b>tk 704-801</b>
330 mm	<b>tk 760-000</b>	<b>tk 704-800</b>
400 mm	-	<b>tk 704-803</b>
450 mm	-	<b>tk 704-802</b>

Taststab, graduiert  
*Palpation probe, graduated*  
 Palpateur gradué  
*Palpador, graduado*  
 Palpatore, graduato

Insufflationskanülen  
*Insufflation needles*

Aiguilles d'insufflation  
*Agujas de insuflación*  
 Aghi d'insufflazione



**Veress**

	Ø 2.0 mm (STANDARD)	Ø 2.7 mm (HIGH FLOW)
55 mm	<b>tk 704-095</b>	-
70 mm	<b>tk 704-156</b>	-
80 mm	<b>tk 704-096</b>	-
100 mm	<b>tk 704-098</b>	<b>tk 704-151</b>
120 mm	<b>tk 704-100</b>	<b>tk 704-150</b>
130 mm	<b>tk 704-157</b>	-
150 mm	<b>tk 704-101</b>	<b>tk 704-152</b>
170 mm	-	<b>tk 704-154</b>
230 mm	<b>tk 754-159</b>	-
260 mm	<b>tk 704-104</b>	-

Saug- und Spülkanülen  
Suction and irrigation cannulas

Canules d'irrigation et aspiration  
Cánulas de irrigación y aspiración  
Cannule per aspirazione ed irrigazione



tk 704-642

Saug-Spülgriff mit Trompetenventilen  
Suction/irrigation handle with trumpet valves

Manche de suction/irrigation avec piston  
Mango de irrigación/aspiración con válvula de trompeta  
Impugnatura di irrigazione/aspirazione con valvola a trompeta



tk 704-644

Saug-Spülgriff mit LL-Anschluss weiblich und Trompetenventilen  
Suction/irrigation handle with LL-connection female and trumpet valves

Poignée pour irrigation/aspiration avec connecteurs LL femelles et valves à piston  
Mango para irrigación/aspiración con conexiones LL hembras y valvulas de trompeta  
Impugnatura di irrigazione/aspirazione con attacco LL female e valvole a trompeta



tk 704-646

Saug-Spülgriff mit Schiebeventil  
Suction/irrigation handle with sliding valve

Manche de lavage/aspiration avec valve à pousser  
Mango de irrigación/aspiración con válvula deslizante  
Impugnatura di irrigazione/aspirazione con valvola a slitta

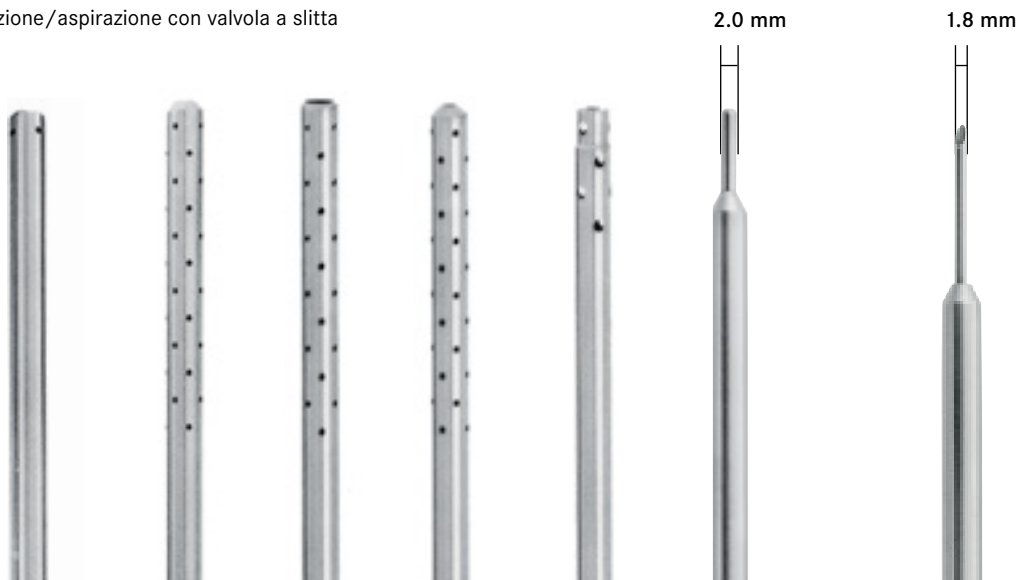

Ø 2.8 mm - 250 mm	tk 770-111-25	-	-	-	-	-	tk 770-110-25
Ø 2.8 mm - 330 mm	tk 770-111	-	-	-	-	-	tk 770-110
Ø 5.0 mm - 500 mm	-	-	-	tk 704-654	-	-	-
Ø 5.0 mm - 330 mm	tk 704-660	tk 704-656	tk 704-650	-	tk 704-652	tk 704-658	tk 704-662

Rundlochsauger Suction tubes	Standard standard	stumpf blunt	stumpf blunt	stumpf blunt	Dissektionskanüle Dissection cannula	Punktionskanüle Punction cannula
Canules d'aspiration Cánulas de aspiración	Standard Estándar	mousse roma	mousse roma	mousse roma	Canule de dissection Cánula de disección	Canule de ponction Cánula de punción
Tubo d'aspirazione	Standard	smusso	smusso	smusso	Cannula da dissezione	Canula a punta d'ago



**Saug- und Spülkanülen**  
*Suction and irrigation cannulas*

Canules d'irrigation et aspiration  
*Cánulas de irrigación y aspiración*  
Cannule per aspirazione ed irrigazione



	240 mm	330 mm	330 mm	
Ø 3.5 mm	<b>tk 704-609</b>			
Ø 5.0 mm		<b>tk 704-608</b>		
Ø 10.0 mm			<b>tk 704-607</b>	
				<b>tk 704-605</b>
<b>tk 704-610</b>		x	x	x

Satz  
Set  
Jeu  
Juego  
Serie

Spülgriff mit Trompetenventilen  
und großem Schlauchanschluss  
*Handle with trumpet valves  
and large tube connector*

Poignée pour irrigation/aspiration avec  
valves à piston et connexion grande  
*Mango para irrigación/aspiración con  
valvulas de trompeta y conexión grande*  
Impugnatura con valvola a trombetta  
e connessione grande per tubo



Ø 5.0 mm	391 mm	<b>tk 704-580</b>	-
Ø 5.0 mm	340 mm	-	<b>tk 704-582</b>

mit Trompetenventilen  
*with trumpet valves*

avec valves à piston  
*con valvulas de trompeta*  
con valvola a trombetta

mit Laserführung  
*with laser tube*

avec guidage à laser  
*con guía laser*  
con canale per Laser

ohne Laserführung  
*without laser tube*

sans guidage à laser  
*sin guía laser*  
senza canale per Laser

**Saug- und Spülkanülen**  
*Suction and irrigation cannulas*

Canules d'irrigation et aspiration  
*Cánulas de irrigación y aspiración*  
Cannule per aspirazione ed irrigazione



**tk 704-121**

Zwei-Wege-Anschluss mit LL für Kontrastmittel  
*Two way stopcock with LL for contrast medium*

Poignée avec deux robinets, connecteur LL, pour substance de contraste  
*Mango con dos grifos, conexión LL, para medio de contraste*  
Raccordo a due vie , LL, per mezzo di contrasto



	Ø 5.0 mm
330 mm	<b>tk 704-602</b>

**Saugrohr mit LL-Anschluss**  
*Suction tube with LL-connection*

Canule d'aspiration avec connecteur LL  
*Cánula de aspiración con conexión LL*  
Tubo d'aspirazione, LL



	Ø 5.0 mm
300 mm	<b>tk 704-603</b>

**Cholangiographie-Führungsrohr mit LL-Anschluss, gebogen**  
*Cholangiogram guide with LL-connection, curved*

Canule de guidage cholangiographie, courbe, avec connecteur LL  
*Cánula de guía cholangiografica, curva, con conexión LL*  
Guida per colangiografia, LL, curva

20.0 mm



	Ø 5.0 mm
330 mm	<b>tk 704-120</b>
450 mm	<b>tk 704-122</b>

**Punktions- und Injektionskanüle, LL-Anschluss, Nadel - Ø 1,4 mm**  
*Puncture and injection cannula, LL-connection, needle - Ø 1.4 mm*

Canule de ponction et injection, aiguille Ø 1,4mm, avec connecteur LL  
*Cánula de punción y de inyección, aguja Ø 1,4mm, con conexión LL*  
Canula per punzione ed iniezione, LL, ago - Ø 1.4 mm

**Modulares Saug- und Spülsystem**  
*Modular suction / irrigation system*

Système modulaire d'aspiration et irrigation  
*Sistema modular de aspiración y irrigación*  
Sistema aspirazione / irrigazione modulare



**tk 704-715**

Saug-/Spül - Pistolenhandgriff mit 2-Wege-Ventil und 2 Schlauchanschlüssen, für adaptierbare Rohre (M8x1 mm)  
*Suction/irrigation pistol handle with 2 way valve and 2 tube connectors, for adaptable tubes (M8x1 mm)*

Poignée d'aspiration/irrigation avec valve de deux voies et 2 connecteurs, connecteur pour tubes d'aspiration (M8x1 mm)  
*Mango de irrigación/aspiración con valvula y 2 conexiones, conexión para vainas de aspiración (M8x1 mm)*

Impugnatura a forma di pistola con valvola a 2 vie, 2 attacchi p. tubi e attacco per tubi d'aspirazione (M8x1 mm)



	x = 340 mm	x = 340 mm
Ø 3.0 mm	<b>tk 704-720</b>	<b>tk 704-730</b>
Ø 5.0 mm	<b>tk 704-721</b>	<b>tk 704-731</b>
Ø 10.0 mm	<b>tk 704-722</b>	<b>tk 704-732</b>

mit 4 Bohrungen  
*with 4 holes*  
avec 4 trous  
*con 4 orificios*  
con 4 fori

mit 4x4 Bohrungen  
*with 4x4 holes*  
avec 4x4 trous  
*con 4x4 orificios*  
con 4x4 fori



	x = 340 mm
Ø 5.0 mm	<b>tk 704-745</b>

Punktions-/Injektionsnadel Ø 1 mm, Anschluss (M8x1 mm)  
*Punction/injection needle Ø 1 mm, connection (M8x1 mm)*

Canule de ponction et injection, Ø 1mm, connecteur (M8x1 mm)  
*Cánula de punción y inyección, Ø 1mm, conexión (M8x1 mm)*  
Canula per punzione ed iniezione, Ø 1 mm (M8x1 mm)

Ventilhandgriffe und monopolare Elektroden  
*Valve handles and monopolar electrodes*

Poignées avec valves, électrodes monopolaires  
*Mangos con valvulas, electrodos monopolares*  
 Manico con valvola, elettrodi monopolari



**tk 704-750**

Saug-/Spül - Pistolenhandgriff mit 2 Wege Schiebeventil und Schlauchanschlüssen, ergonomische Griffform, vergrößerter Saugkanal, gerade Durchgänge, Komfortbedienung durch kleinen Schwenkbereich des Schiebeventils  
*Suction / irrigation pistol handle with 2 way valve and tube connectors, ergonomic handle, larger suction canula, straight channels, comfortable handling due to movement of the lever*

Poignée d'aspiration/irrigation avec valve de deux voies et 2 connecteurs, forme ergonomique, canaux larges, manipulation confortable

*Mango de irrigación/aspiración con valvula y 2 conexiones, forma ergonomica, canales grandes, manipulación confortable*

Impugnatura a forma di pistola con valvola a 2 vie, 2 attacchi p. tubi e attacco per tubi d'aspirazione (M8x1 mm)



	330 mm	450 mm
Ø 3.0 mm	<b>tk 704-751</b>	
Ø 5.0 mm	<b>tk 704-752</b>	<b>tk 704-752-45</b>
Ø 10.0 mm	<b>tk 704-753</b>	<b>tk 704-753-45</b>

Saug-/Spülrohr  
*Suction/irrigation tube*

Tube d'irrigation/aspiration  
*Vaina de irrigación/aspiración*  
 Tubo d'aspirazione/irrigazione



**tk 704-760**

Elektrodenadapter für Saug-/Spül-Pistolenhandgriff (tk 704-750), 360° drehbar  
*Adapter for electrodes for suction/irrigation handle (tk 704-750), 360° rotatable*

Adapteur pour électrodes pour poignée (tk 704-750), rotatif de 360°  
*Adaptator para electrodos para mango (tk 704-750), giratorio de 360°*  
 Adattore per elettrodi per impugnatura (tk 704-750), rotante 360°

Ventilhandgriffe und monopolare Elektroden  
*Valve handles and monopolar electrodes*





Poignées avec valves, électrodes monopolaires  
*Mangos con valvulas, electrodos monopolares*  
 Manico con valvola, elettrodi monopolari



**tk 795-4910**

Pistolengriff mit wartungsfreiem 2-Wegeventil für adaptierbare HF-Elektroden mit Saug-/Spülkanal. Mit Drehadapter und seitlichem HF-Anschluss. 2 Universal-Schlauchanschlüsse.  
*Handle with 2-way-valve for adaptable HF-electrodes with suction/irrigation channel. With rotating adaptor and lateral HF-connector. Two universal hose connectors.*

Poignée d'aspiration/irrigation avec valve de deux voies et 2 connecteurs, forme ergonomique, connecteur monopolaire latéral  
*Mango de irrigación/aspiración con valvula y 2 conexiones, forma ergonomica, conexión monopolar lateral*  
 Impugnatura a forma di pistola con valvola a 2 vie, per elettrodi AF con canale d'aspirazione / irrigazione, attacco AF

	Ø 5.0 mm	330 mm
 1:1	<b>Knopf</b> <i>Ball point</i> Boule <i>Bola</i> Sfera	<b>tk 704-761</b>
 1:1	<b>Rundhaken</b> <i>Hook</i> Crochet <i>Gancho</i> Uncino curvo	<b>tk 704-762</b>
 1:1	<b>Haken 90°</b> <i>Hook 90°</i> Crochet 90° <i>Gancho 90°</i> Uncino 90°	<b>tk 704-763</b>
 1:1	<b>Spatel</b> <i>Spatula</i> Spatule <i>Espátula</i> Spatola	<b>tk 704-764</b>
 1:1	<b>Nadel</b> <i>Needle</i> Aiguille <i>Aguja</i> Ago	<b>tk 704-765</b>

**Koagulations-Saugkanülen, monopolar**  
*Coagulation suction tubes, monopolar*

Canules á coagulation, monopolaires  
*Cánulas para coagulación, monopolares*  
 Canule per aspirazione, monopolari

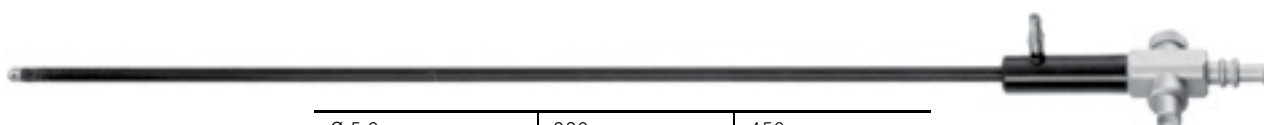

	Ø 5.0 mm	330 mm	450 mm
 Spatel <i>Spatula</i> Spatule <i>Espátula</i> Spatola 1:1		tk 706-180	tk 706-180-45
 Rundhaken <i>Hook</i> Crochet <i>Gancho</i> Uncino curvo 1:1		tk 706-182	tk 706-182-45
 Haken 90° <i>Hook 90°</i> Crochet 90° <i>Gancho 90°</i> Uncino 90° 1:1		tk 706-184	tk 706-184-45
 Knopf <i>Ball point</i> Boule <i>Bola</i> Sfera 1:1		tk 706-186	tk 706-186-45
 Nadel <i>Needle</i> Aiguille <i>Aguja</i> Ago 1:1		tk 706-187	tk 706-187-45

Elektrode, Saugkanüle mit Trompetenventil und LL-Ansatz  
*Electrode, suction tube with trumpet valve and LL-connection*

Électrode, canule avec valve à piston et connecteur LL

*Electrodo, cánula con valvula de trompeta y conexión LL*

Elettrodi, canule per aspirazione con valvola a trombetta, attacco LL

# TEKNOLINE

Laparoscopy Instruments

Tekno-Medical Laparoskopie-Instrumente sind dreiteilig zerlegbar, autoklavierbar und wiederverwendbar. Alle Instrumente sind komplett drehbar für eine maximale Beweglichkeit.

Unsere Laparoskopie-Instrumente sind robust ausgeführt und sie zeichnen sich durch eine qualitativ hochwertige Verarbeitung aus. Tekno-Medical Kunststoff-Handgriffe bestehen darüber hinaus durch einen großen Daumenring, sowie ein ergonomisches Design, welches bestmöglich das ermüdungsfreie Arbeiten unterstützt.

*These instruments are detachable in three parts, autoclavable and reuseable. All systems are completely rotatable, for universal use. Our laparoscopy instruments are robust and safe.*

*Their outstanding quality is achieved to latest knowledge in production. Tekno-Medical plastic handles also convince with a large thumb ring as well as an ergonomic design which supports fatigue-free work in the best possible way.*

Les instruments de coelioscopie de Tekno-Medical sont démontables en trois pièces, autoclavables et réutilisables. Tous les instruments sont complètement rotatif pour une agité maximale.

Nos instruments sont robustes et se distinguent par leur haut niveau de qualité. Les poignées en plastique de Tekno-Medical convainquent également par leur large anneau pour le pouce et leur design ergonomique, qui facilite le travail sans fatigue.

*Los instrumentos de laparoscopia de Tekno-Medical son desmontables en tres partes, autoclavables y reutilisables. Todos los instrumentos son completamente giratorios para una movilidad maxima. Nuestros instrumentos son robustos y se caracterizan por su alto nivel de calidad. Los mangos de plástico de Tekno-Medical convencen también por su gran anillo para el pulgar y por su diseño ergonómico que facilita el trabajo sin fatiga de la mejor manera posible.*

Strumenti per Laparoscopia delta Tekno-Medical sono smontabili, autoclavabili ed in tre pezzi riusabili. Tutti gli strumenti sono girevoli a 360°. I ns. strumenti sono molto robusti e di altissima qualità. Le maniglie in plastica di Tekno-Medical convincono anche per l'ampio anello per il pollice e il design ergonomico, che rende il lavoro senza fatica il più semplice possibile.





**Laparoskopie-Handgriffe**  
*Handles for laparoscopy instruments*

Poignées de coelioscopie  
*Mangos de laparoscopia*  
Manici per pinze per laparoscopia

			
		<p><b>tk 775-4003</b></p>	<p><b>tk 775-4004</b></p>
<p>für System <i>for system</i> pour système <i>para sistema</i> per sistema</p>	<p>ohne Sperre <i>without ratchet</i> sans crémaillère <i>sin cremallera</i> senza cremagliera</p>	<p>mit Sperre <i>with ratchet</i> avec crémaillère <i>con cremallera</i> con cremagliera</p>	

			
		<p><b>tk 775-3995</b></p>	<p><b>tk 775-4005</b></p>
<p>für System <i>for system</i> pour système <i>para sistema</i> per sistema</p>	<p>mit zuschaltbarer Sperre <i>with shiftable ratchet</i> avec crémaillère à rajouter <i>con cremallera a adjuntar</i> con cremagliera disattivabile</p>	<p>mit Sperre <i>with ratchet</i> avec crémaillère <i>con cremallera</i> con cremagliera</p>	

Laparoskopie-Handgriffe  
Handles for laparoscopy instruments

Poignées de coelioscopie  
Mangos de laparoscopia  
Manici per pinze per laparoscopia

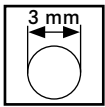

**tk 775-4303**

**tk 775-4304**

für System  
for system  
pour système  
para sistema  
per sistema

ohne Sperre  
without ratchet  
sans crémaillère  
sin cremallera  
senza cremagliera

mit Sperre  
with ratchet  
avec crémaillère  
con cremallera  
con cremagliera

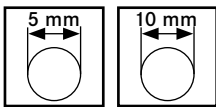

**tk 775-4002**

**tk 775-4001**

für System  
for system  
pour système  
para sistema  
per sistema

ohne Sperre  
without ratchet  
sans crémaillère  
sin cremallera  
senza cremagliera

mit Sperre  
with ratchet  
avec crémaillère  
con cremallera  
con cremagliera

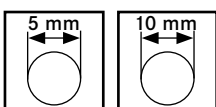

**tk 775-4000**

**tk 775-4006**

für System  
for system  
pour système  
para sistema  
per sistema

ohne Sperre  
without ratchet  
sans crémaillère  
sin cremallera  
senza cremagliera

mit Sperre  
with ratchet  
avec crémaillère  
con cremallera  
con cremagliera

Schaftrohre für Laparoskopie-Instrumente  
Shafts for laparoscopy instruments

Gaines pour les instruments de coelioscopie  
Vainas para los instrumentos de laparoscopia  
Tubi d'asta per pinze per laparoscopia



TEKNO LINE

	Ø 3.0 mm	Ø 5.0 mm	Ø 10.0 mm	Ø 5.0 mm
250 mm	tk 775-4114-25	tk 775-4009	tk 775-4012-25	-
330 mm	tk 775-4114	tk 775-4010	tk 775-4012	tk 775-4010LL
450 mm	tk 775-4114-45	tk 775-4011	tk 775-4012-45	tk 775-4010-45LL

	Ø 5.0 mm	Ø 10.0 mm
	tk 775-4013	-
	tk 775-4014	tk 775-4016
	tk 775-4015	-

Außenrohr isoliert  
Shaft insulated

Gaine isolée  
Vaina aislada

Tubi esterni isolati

mit LL-Spülanschluss  
with LL irrigation connection

avec raccord d'irrigation LL  
con conexión de irrigación LL  
con accesso LL

Außenrohr nicht isoliert  
Shaft not insulated

Gaine non isolée  
Vaina no aislada

Tubi esterni non isolati



TEKNO LINE

	Ø 5.0 mm	Ø 5.0 mm	Ø 5.0 mm	Ø 5.0 mm
330 mm	tk 775-4110 ●	tk 775-4111 ●	tk 775-4112 ●	tk 775-4113 ●

Außenrohr isoliert  
Shaft insulated

Gaine isolée  
Vaina aislada

Tubi esterni isolati



Andere Längen auf Anfrage lieferbar  
Other lengths available upon request

Autres longueurs sont disponibles sur demande  
Otras longitudes son disponibles según demanda  
Altre lunghezze a richiesta

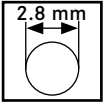

**MIKRO Instrumente, nicht zerlegbar, mit LL**  
**MICRO instruments, not detachable, with LL**

**MICRO instruments non-démontables, connecteur LL**  
**MICRO instrumentos non desmontables, conexión LL**  
**MICRO strumenti non smontabili, con LL**

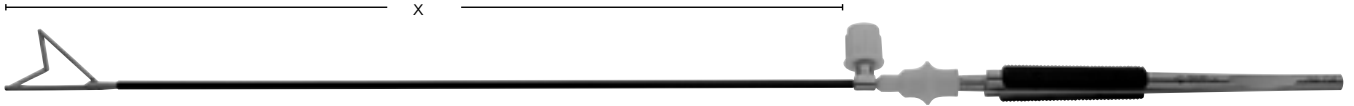

	x = 220 mm	x = 250 mm
Ø 2.8 mm	<b>tk 783-710</b>	<b>tk 783-711</b>

**Fasszange, atraumatisch, gebogen, isoliert, mit Sperre**  
**Grasping forceps, atraumatic, curved, insulated, with ratchet**  
 Pince à saisir, atraumatique, courbe, isolée, avec crémaillère  
 Pinza de agarre, atraumatica, curva, aislada, con cierre  
 Pinza da presa, atraumatica, curva, isolata con cremagliera



	x = 220 mm	x = 250 mm
Ø 2.8 mm	<b>tk 783-720</b>	<b>tk 783-721</b>

**Schere, stumpf, gebogen, isoliert**  
**Scissors, blunt, curved, insulated**  
 Ciseaux, mousse, courbe, isolé  
 Tijera, roma, curva, aislada  
 Forbice, smussa, curva, isolata



	x = 220 mm	x = 250 mm
Ø 2.8 mm	<b>tk 783-730</b>	<b>tk 783-731</b>

**Nadelhalter, gerade, isoliert, mit Sperre**  
**Needleholder, straight, insulated, with ratchet**  
 Porte-aiguille, droit, isolé, avec crémaillère  
 Porta-agujas, recto, aislado, con cierre  
 Portaghi, retto, isolato con cremagliera



	x = 220 mm	x = 250 mm
Ø 2.8 mm	<b>tk 783-740</b>	<b>tk 783-741</b>

**Fasszange, atraumatisch, gerade, gefenstert, isoliert, mit Sperre**  
**Grasping forceps, atraumatic, straight, fenestrated, insulated, with ratchet**  
 Pince à saisir, atraumatique, droite, fenêtrée, isolée, avec crémaillère  
 Pinza de agarre, atraumatica, recta, fenestrada, aislada, con cierre  
 Pinza da presa, atraumatica, retta, fenestrata, isolata con cremagliera



	x = 220 mm	x = 250 mm
Ø 2.8 mm	<b>tk 783-750</b>	<b>tk 783-751</b>

**Retraktor, isoliert, mit Sperre**  
**Tissue retractor, insulated, with ratchet**  
 Retracteur, isolé, avec crémaillère  
 Separador, aislado, con cierre  
 Retrattore, isolato, con cremagliera

Mini-Instrumente, zerlegbar  
Mini-Instruments, detachable

Mini instruments, démontables  
Mini instrumentos, desmontables  
Strumenti mini, smontabili

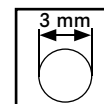

ohne Sperre  
without ratchet  
sans crémaillère  
sin cremallera  
senza cremagliera











mit Sperre  
with ratchet  
avec crémaillère  
con cremallera  
con cremagliera



Einsatz allein  
Insert only  
Insert seul  
Inserto solo  
Inserto solo

TEKNOLINE

		Ø 3.0 mm	Ø 3.0 mm	Ø 3.0 mm
 1:1 <b>Cobra, Fasszange, 2x1 Zähne</b> <i>Cobra, grasping forceps 2x1 teeth</i> Pince à saisir Cobra, 2x1 dents Cobra, pinza da agarre 2x1 dientes Cobra, pinze da presa 2x1 denti	250 mm	tk 783-102-25	tk 783-202-25	tk 783-602-25
	330 mm	tk 783-102	tk 783-202	tk 783-602
	450 mm	tk 783-102-45	tk 783-202-45	tk 783-602-45
 1:1 <b>MARYLAND Dissektor/Fasszange</b> <i>MARYLAND dissecting/grasping forceps</i> MARYLAND pince à dissection/saisir MARYLAND disectora/pinza de agarre MARYLAND pinza da dissezione/presa	250 mm	tk 783-104-25	tk 783-204-25	tk 783-604-25
	330 mm	tk 783-104	tk 783-204	tk 783-604
	450 mm	tk 783-104-45	tk 783-204-45	tk 783-604-45
 1:1 <b>DELPHIN Präparier- und Fasszange</b> <i>DOLPHIN dissecting and grasping forceps</i> Dauphin, pince à dissection Delfin, pinza de dissección Delfino, pinza de presa e dissezione	250 mm	tk 783-106-25	tk 783-206-25	tk 783-606-25
	330 mm	tk 783-106	tk 783-206	tk 783-606
	450 mm	tk 783-106-45	tk 783-206-45	tk 783-606-45
 1:1 <b>Fasszange, gefenestert</b> <i>Grasping forceps, fenestrated</i> Pince à saisir, fenêtré Pinza de agarre, fenestrada Pinza da presa, finestrata	250 mm	tk 783-107-25	tk 783-207-25	tk 783-607-25
	330 mm	tk 783-107	tk 783-207	tk 783-607
	450 mm	tk 783-107-45	tk 783-207-45	tk 783-607-45
 1:1 <b>METZENBAUM Schere, gebogen</b> <i>METZENBAUM scissors, curved</i> METZENBAUM ciseaux, courbes METZENBAUM tijera, curva METZENBAUM forbice curva	250 mm	tk 783-120-25	-	tk 783-620-25
	330 mm	tk 783-120		tk 783-620
	450 mm	tk 783-120-45		tk 783-620-45
 1:1 <b>METZENBAUM Schere, gerade</b> <i>METZENBAUM scissors, straight</i> METZENBAUM ciseaux, droites METZENBAUM tijera, recta METZENBAUM forbice retta	250 mm	tk 783-123-25	-	tk 783-623-25
	330 mm	tk 783-123		tk 783-623
	450 mm	tk 783-123-45		tk 783-623-45
 1:1 <b>Hakenschere</b> <i>Hook scissors</i> Ciseaux à crochet Tijera de gancho Forbice ad uncino	250 mm	tk 783-124-25	-	tk 783-624-25
	330 mm	tk 783-124		tk 783-624
	450 mm	tk 783-124-45		tk 783-624-45
 1:1 <b>Biopsiestanze, durchschneidend</b> <i>Biopsy forceps, through cutting type</i> Pince à biopsie, coupante Pinza biopsia, cortante Pinza tagliente per biopsia	250 mm	tk 783-125-25	tk 783-225-25	tk 783-625-25
	330 mm	tk 783-125	tk 783-225	tk 783-625
	450 mm	tk 783-125-45	tk 783-225-45	tk 783-625-45
 1:1 <b>Biopsiezange</b> <i>Biopsy forceps</i> Pince à biopsie Pinza biopsia Pinza per biopsia	250 mm	tk 783-128-25	tk 783-228-25	tk 783-628-25
	330 mm	tk 783-128	tk 783-228	tk 783-628
	450 mm	tk 783-128-45	tk 783-228-45	tk 783-628-45

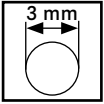

Mini-Instrumente, zerlegbar  
*Mini-Instruments, detachable*

Mini instruments, démontables  
*Mini instrumentos, desmontables*  
Strumenti mini, smontabili











ohne Sperre  
*without ratchet*  
sans crémaillère  
*sin cremallera*  
senza cremagliera

mit Sperre  
*with ratchet*  
avec crémaillère  
*con cremallera*  
con cremagliera

Einsatz allein  
*Insert only*  
Insert seul  
*Inserto solo*  
Inserto solo

**TEKNOLINE**

		Ø 3.0 mm	Ø 3.0 mm	Ø 3.0 mm
 1:1	<b>Biopsie Stanze</b> <i>Biopsy forceps</i>	250 mm	tk 783-145-25	tk 783-245-25
	Pince à biopsie	330 mm	tk 783-145	tk 783-245
	<i>Pinza de biopsia</i>	450 mm	tk 783-145-45	tk 783-245-45
	Pinze per biopsia			tk 783-645-45
 1:1	<b>Löffelzange</b> <i>Spoon-forceps</i>	250 mm	tk 783-127-25	tk 783-227-25
	Pince à cuillère	330 mm	tk 783-127	tk 783-227
	<i>Pinza de cuchara</i>	450 mm	tk 783-127-45	tk 783-227-45
	Pinza a cucchiaio			tk 783-627-45
 1:1	<b>DEBAKEY, atraumatisch, 14mm lang</b> <i>DEBAKEY, atraumatic, 14mm jaw length</i>	250 mm	tk 783-159-25	tk 783-259-25
	DEBAKEY, atraumatique, 14mm	330 mm	tk 783-159	tk 783-259
	<i>DEBAKEY, atraumatica, 14mm</i>	450 mm	tk 783-159-45	tk 783-259-45
	DEBAKEY atraumatica, morso lungo 14mm			tk 783-659-45
 1:1	<b>JOHAN, 20 mm, gezahntes Maul</b> <i>JOHAN, 20mm, serrated jaws</i>	250 mm	tk 783-158-25	tk 783-258-25
	JOHAN, 20mm, dentelée	330 mm	tk 783-158	tk 783-258
	<i>JOHAN, 20mm, dentada</i>	450 mm	tk 783-158-45	tk 783-258-45
	JOHAN, 20 mm, morso zigrinato			tk 783-658-45
 1:1	<b>BABCOCK Fasszange</b> <i>BABCOCK-forceps</i>	250 mm	tk 783-157-25	tk 783-257-25
	BABCOCK pince à saisir	330 mm	tk 783-157	tk 783-257
	<i>BABCOCK pinza de agarre</i>	450 mm	tk 783-157-45	tk 783-257-45
	BABCOCK pinza da presa			tk 783-657-45
 1:1	<b>Multiple Fasszange</b> <i>Multiple grasping forceps</i>	250 mm	tk 783-155-25	tk 783-255-25
	Pince strié, multiple	330 mm	tk 783-155	tk 783-255
	<i>Pinza estriada, multiple</i>	450 mm	tk 783-155-45	tk 783-255-45
	Pinza da presa universale			tk 783-655-45
 1:1	<b>Fasszange mit starker Zahnung</b> <i>Grasping forceps, strong teeth</i>	250 mm	tk 783-154-25	tk 783-254-25
	Mors fortement strié	330 mm	tk 783-154	tk 783-254
	<i>Boca fuertemente estriada</i>	450 mm	tk 783-154-45	tk 783-254-45
	Pinza da presa con dentatura forte			tk 783-654-45
 1:1	<b>Fasszange mit 4x5 Zähnen, glatt</b> <i>Grasping forceps, 4x5 teeth, smooth</i>	250 mm	tk 783-152-25	tk 783-252-25
	Pince à saisir, 4x5 dents, lisse	330 mm	tk 783-152	tk 783-252
	<i>Pinza de agarre, 4x5 dientes, lisa</i>	450 mm	tk 783-152-45	tk 783-252-45
	Pinza da presa, 4x5 denti, liscia			tk 783-652-45
 1:1	<b>Fasszange, 2x4 gezahnt</b> <i>Grasping forceps, 2x4 teeth</i>	250 mm	tk 783-151-25	tk 783-251-25
	Pince à saisir, 2x4 dents	330 mm	tk 783-151	tk 783-251
	<i>Pinza de agarre, 2x4 dientes</i>	450 mm	tk 783-151-45	tk 783-251-45
	Pinza da presa, 2x4 denti			tk 783-651-45

Mini-Instrumente, zerlegbar  
Mini-Instruments, detachable

Mini instruments, démontables  
Mini instrumentos, desmontables  
Strumenti mini, smontabili

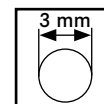

ohne Sperre  
without ratchet  
sans crémaillère  
sin cremallera  
senza cremagliera









mit Sperre  
with ratchet  
avec crémaillère  
con cremallera  
con cremagliera

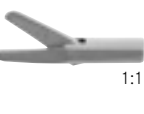

Einsatz allein  
Insert only  
Insert seul  
Inserto solo  
Inserto, solo

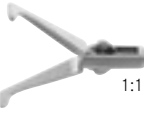
TEKNOLINE

		Ø 3.0 mm	Ø 3.0 mm	Ø 3.0 mm
 <p>1:1</p>	MARYLAND, kreuzgerieft MARYLAND, cross serrated	250 mm	tk 783-156-25	tk 783-256-25
	MARYLAND, strié en cruciforme	330 mm	tk 783-156	tk 783-256
	MARYLAND, estriada en cruciforma	450 mm	tk 783-156-45	tk 783-256-45
	MARYLAND, zigrinata a croce			tk 783-656-25
 <p>1:1</p>	Fasszange, gerieft Grasping forceps, serrated	250 mm	tk 783-150-25	tk 783-250-25
	Pince strié	330 mm	tk 783-150	tk 783-250
	Pinza estriada	450 mm	tk 783-150-45	tk 783-250-45
	Pinza da presa zigrinata			tk 783-650-25
 <p>1:1</p>	Mikroschere Micro scissors	250 mm	tk 783-143-25	-
	Ciseaux micro	330 mm	tk 783-143	-
	Tijera micro	450 mm	tk 783-143-45	-
	Forbici micro			tk 783-643-25
 <p>1:1</p>	Peritoneal-Schere, 1 Blatt gezahnt Peritoneal scissors, 1 blade serrated	250 mm	tk 783-141-25	-
	Ciseaux péritonéales, une lame crantée	330 mm	tk 783-141	-
	Tijera peritoneal, una hoja dentada	450 mm	tk 783-141-45	-
	Forbici paritoneale, 1 lama dentellata			tk 783-641-25
 <p>1:1</p>	Fasszange mit Reservoir Grasping forceps with cup	250 mm	tk 783-132-25	tk 783-232-25
	Pince avec cuillère	330 mm	tk 783-132	tk 783-232
	Pinza con cuchara	450 mm	tk 783-132-45	tk 783-232-45
	Pinza da presa con cucchiaio			tk 783-632-25
 <p>1:1</p>	KELLY Fasszange KELLY grasping forceps	250 mm	tk 783-129-25	tk 783-229-25
	KELLY, pince à saisir	330 mm	tk 783-129	tk 783-229
	KELLY, pinza de agarre	450 mm	tk 783-129-45	tk 783-229-45
	KELLY, pinza da presa			tk 783-629-25
 <p>1:1</p>	MIXTER Fasszange, 90° gewinkelt MIXTER grasping forceps, 90° angled	250 mm	tk 783-130-25	tk 783-230-25
	MIXTER, 90° angulé	330 mm	tk 783-130	tk 783-230
	MIXTER, 90° angulada	450 mm	tk 783-130-45	tk 783-230-45
	MIXTER, pinza da presa angolata a 90°			tk 783-630-25
 <p>1:1</p>	Mikroschere, gebogen Micro scissors, curved	250 mm	tk 783-142-25	-
	Ciseaux micro, courbes	330 mm	tk 783-142	-
	Tijera micro, curva	450 mm	tk 783-142-45	-
	Forbici micro, curva			tk 783-642-25



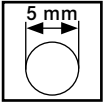

Scheren, zerlegbar  
*Scissors, detachable*

Ciseaux, démontables  
*Tijeras, desmontables*  
Forbici, smontabili

### TEKNOSTEEL

Die Schneide der **TEKNOSTEEL** - Schere besteht aus einer speziellen rostfreien Stahllegierung, die für lange Zeit die optimale Schärfe und Widerstand gegen Korrosion bietet. Die verbesserte Härte des verwendeten Materials sorgt für lange konstante Schärfe und spart dadurch unnötige Kosten für häufiges Nachschleifen und der damit verbundenen Ausfallzeit des Instruments. Schneidet sogar mehrfach Federstahlblech ohne spürbaren Schärfeverlust.

The **TEKNOSTEEL** - scissors are made of a special stainless steel which guarantees an optimal sharpness for a long time and a resistance against corrosion. The improved hardness of this type of steel leads to a long and constant sharpness and helps to save a lot of costs for resharping the scissors frequently. It repeatedly cuts steel sheets without losing sharpness.

Les lames des ciseaux **TEKNOSTEEL** sont produites d'une alliage d'acier spéciale, qui garantit la maintenance de la coupe pour longtemps et une haute résistance contre corrosion. La dureté améliorée des matériaux utilisés réduit la nécessité d'affûtage. Les ciseaux coupent même des lames d'acier fines.

Las hojas de las tijeras **TEKNOSTEEL** son producidas de una aleación de acero especial, que garantiza la calidad del corte mas larga y una alta resistencia contro corrosión. La dureza ameliorada del material utilizado reduce la necesidad de afilar las tijeras. Las tijeras cortan también hojas de acero finas.

Il morso della forbici **TEKNOSTEEL** è prodotto con un acciaio inossidabile speciale che assicura un taglio ottimale ed una resistenza contro la corrosione per un tempo lungo. Ciò vi fa risparmiare dei costi per ulteriori affilature ed evita la manutenzione dello strumento.



ohne Sperre  
*without ratchet*  
sans crémaillère  
*sin cremallera*  
senza cremagliera





ohne Sperre  
*without ratchet*  
sans crémaillère  
*sin cremallera*  
senza cremagliera



Einsatz allein  
*Insert only*  
Insert seul  
*Inserto solo*  
Inserto, solo

### TEKNOLINE

		Ø 5.0 mm	Ø 5.0 mm	Ø 5.0 mm
 1:1 <b>Hakenschere</b> <i>Hook scissors</i> Ciseaux à crochet <i>Tijera de gancho</i> Forbici a gancio	250 mm 330 mm 450 mm	tk 775-4020-25 TSC tk 775-4020 TSC tk 775-4020-45 TSC	tk 775-4020-25 TSCM tk 775-4020 TSCM tk 775-4020-45 TSCM	tk 775-4020-25 TS tk 775-4020 TS tk 775-4020-45 TS
 1:1 <b>Peritoneal-Schere</b> <i>Peritoneal-scissors</i> Ciseaux péritonéales <i>Tijera peritonal</i> Forbici peritoneale	250 mm 330 mm 450 mm	tk 775-4026-25 TSC tk 775-4026 TSC tk 775-4026-45 TSC	tk 775-4026-25 TSCM tk 775-4026 TSCM tk 775-4026-45 TSCM	tk 775-4026-25 TS tk 775-4026 TS tk 775-4026-45 TS
 1:1 <b>Metzenbaum-Schere, gebogen</b> <i>Metzenbaum-scissors, curved</i> Metzenbaum ciseaux, courbes <i>Metzenbaum tijera, curva</i> Metzenbaum forbici, curva	250 mm 330 mm 450 mm	tk 775-4027-25 TSC tk 775-4027 TSC tk 775-4027-45 TSC	tk 775-4027-25 TSCM tk 775-4027 TSCM tk 775-4027-45 TSCM	tk 775-4027-25 TS tk 775-4027 TS tk 775-4027-45 TS



Nadelhalter, zerlegbar  
Needleholder, detachable

Porte-aiguilles, démontables  
Porta-agujas, desmontables  
Porta aghi, smontabili

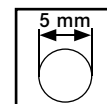

**TEKNOSTEEL**

Die Maulteile der **TEKNOSTEEL** - Instrumente bestehen aus einer speziellen rostfreien Stahllegierung, die für lange Zeit die optimale Beibehaltung der Maulstruktur und Widerstand gegen Korrosion bietet. Die verbesserte Härte des verwendeten Materials spart unnötige Kosten für häufiges Nacharbeiten und der damit verbundenen Ausfallzeit des Instruments.

The **TEKNOSTEEL** - instruments are made of a special stainless steel which guarantees the keeping of the optimal jaw structure for a long time and a resistance against corrosion. The improved hardness of this type of steel helps to save a lot of costs for frequent rework.

Les mors du instruments **TEKNOSTEEL** sont produites d'une alliage d'acier spéciale, qui garantit la maintenance de la structure du mors pour longtemps et une haute résistance contre corrosion. La dureté amélioré des matériaux utilisés réduit la nécessité d'affûtage.

Las bocas de los instrumentos **TEKNOSTEEL** son producidas de una aleación de acero especial, que garantiza la estructura de la boca mas larga y una alta resistencia contro corrosión. La dureza ameliorada del material utilizado reduce la necesidad de controlas frecuentes.

Il morso dei porta aghi **TEKNOSTEEL** è prodotto con un acciaio inossidabile speciale che assicura una presa ottimale ed una resistenza contro corrosione per un lungo tempo. Ciò vi fa risparmiare dei costi per eventuali riparazioni dello strumento.



ohne Sperre  
without ratchet  
sans crémaillère  
sin cremallera  
senza cremagliera







mit Sperre  
with ratchet  
avec crémaillère  
con cremallera  
con cremagliera



Einsatz allein  
Insert only  
Inserto solo  
Inserto, solo

**TEKNOLINE**

		Ø 5.0 mm	Ø 5.0 mm	Ø 5.0 mm
 1:1 Nadelhalter gerade <i>Needle holder pointed model</i> Porte-aiguilles droite Porta-agujas recta Porta aghi retto	250 mm	tk 775-4214-25 TSC	tk 775-4214-25 TSCS	tk 775-4214-25 TS
	330 mm	tk 775-4214 TSC	tk 775-4214 TSCS	tk 775-4214 TS
	450 mm	tk 775-4214-45 TSC	tk 775-4214-45 TSCS	tk 775-4214-45 TS
 1:1 Nadelhalter rechts gebogen <i>Needle holder right curved</i> Porte-aiguilles droite courbe Porta-agujas dereda curva Porta aghi a destra curvo	250 mm	tk 775-4212-25 TSC	tk 775-4212-25 TSCS	tk 775-4212-25 TS
	330 mm	tk 775-4212 TSC	tk 775-4212 TSCS	tk 775-4212 TS
	450 mm	tk 775-4212-45 TSC	tk 775-4212-45 TSCS	tk 775-4212-45 TS
 1:1 Nadelhalter links gebogen <i>Needle holder left curved</i> Porte-aiguilles gauche courbe Porta-agujas izquierda curva Porta aghi a sinistra curvo	250 mm	tk 775-4213-25 TSC	tk 775-4213-25 TSCS	tk 775-4213-25 TS
	330 mm	tk 775-4213 TSC	tk 775-4213 TSCS	tk 775-4213 TS
	450 mm	tk 775-4213-45 TSC	tk 775-4213-45 TSCS	tk 775-4213-45 TS
 1:1 Nadelhalter schnabelförmig <i>Needle holder beaked</i> Porte-aiguilles en forme de bec Porta-agujas curva en forma de pico Porta aghi a forma di becco	250 mm	tk 775-4210-25 TSC	tk 775-4210-25 TSCS	tk 775-4210-25 TS
	330 mm	tk 775-4210 TSC	tk 775-4210 TSCS	tk 775-4210 TS
	450 mm	tk 775-4210-45 TSC	tk 775-4210-45 TSCS	tk 775-4210-45 TS

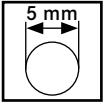

Scheren, zerlegbar  
*Scissors, detachable*

Ciseaux, démontables  
*Tijeras, desmontables*  
Forbici, smontabili



ohne Sperre  
*without ratchet*  
sans crémaillère  
*sin cremallera*  
senza cremagliera

Einsatz allein  
*Insert only*  
Insert seul  
*Inserto solo*  
Inserto, solo

**TEKNOLINE**

		Ø 5.0 mm	Ø 5.0 mm
 1:1	<b>Hakenschere</b> <i>Hook scissors</i>	250 mm	tk 775-4020-25 C
	Ciseaux à crochet	330 mm	tk 775-4020 C
	<i>Tijera de gancho</i>	450 mm	tk 775-4020-45 C
	Forbici a gancio		
 1:1	<b>METZENBAUM-Schere</b> <i>METZENBAUM-scissors</i>	250 mm	tk 775-4022-25 C
	METZENBAUM ciseaux	330 mm	tk 775-4022 C
	<i>METZENBAUM tijera</i>	450 mm	tk 775-4022-45 C
	METZENBAUM forbici		
 1:1	<b>METZENBAUM-Schere, gebogen</b> <i>METZENBAUM-scissors, curved</i>	250 mm	tk 775-4023-25 C
	METZENBAUM ciseaux, courbes	330 mm	tk 775-4023 C
	<i>METZENBAUM tijera, curva</i>	450 mm	tk 775-4023-45 C
	METZENBAUM forbici, curve		
 1:1	<b>Mikroschere</b> <i>Micro scissors</i>	250 mm	tk 775-4024-25 C
	Ciseaux micro	330 mm	tk 775-4024 C
	<i>Tijera micro</i>	450 mm	tk 775-4024-45 C
	Forbici micro		
 1:1	<b>Mikroschere, gebogen</b> <i>Micro scissors, curved</i>	250 mm	tk 775-4025-25 C
	Ciseaux micro, courbes	330 mm	tk 775-4025 C
	<i>Tijera micro, curva</i>	450 mm	tk 775-4025-45 C
	Forbici micro, curve		
 1:1	<b>Peritoneal-Schere, 1 Blatt gezahnt</b> <i>Peritoneal scissors, 1 blade serrated</i>	250 mm	tk 775-4026-25 C
	Ciseaux péritonéales, une lame crantée	330 mm	tk 775-4026 C
	<i>Tijera peritoneal, una hoja dentada</i>	450 mm	tk 775-4026-45 C
	Forbici paritoneale, 1 lama dentellata		
 1:1	<b>METZENBAUM-Schere, gebogen, lang</b> <i>METZENBAUM-scissors, curved, long</i>	250 mm	tk 775-4027-25 C
	METZENBAUM ciseaux, courbes, longue	330 mm	tk 775-4027 C
	<i>METZENBAUM tijera, curva, larga</i>	450 mm	tk 775-4027-45 C
	METZENBAUM forbici, curve, lama lunga		
 1:1	<b>OP-Schere</b> <i>OP-scissors</i>	250 mm	tk 775-3928-25 C
	Ciseaux à opérations	330 mm	tk 775-3928 C
	<i>Tijera para operaciones</i>	450 mm	tk 775-3928-45 C
	Forbici per operazione		
 1:1	<b>OP-Schere, gebogen</b> <i>OP-scissors, curved</i>	250 mm	tk 775-3929-25 C
	Ciseaux à opérations, courbes	330 mm	tk 775-3929 C
	<i>Tijera para operaciones, curva</i>	450 mm	tk 775-3929-45 C
	Forbici per operazione, curve		

Biopsiezangen, zerlegbar  
*Biopsy forceps, detachable*

Pinces à biopsie, démontables  
*Pinzas de biopsia, desmontables*  
 Pinze per biopsia, smontabili

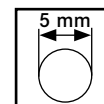

ohne Sperre  
*without ratchet*  
 sans crémaillère  
*sin cremallera*  
 senza cremagliera

mit Sperre  
*with ratchet*  
 avec crémaillère  
*con cremallera*  
 con cremagliera

Einsatz allein  
*Insert only*  
 Insert seul  
*Inserto solo*  
 Inserto, solo

TEKNOLINE

		Ø 5.0 mm	Ø 5.0 mm	Ø 5.0 mm
 1:1 <b>Biopsie Stanze</b> <i>Biopsy forceps</i> Pince à biopsie <i>Pinza de biopsia</i> Pinze per biopsia	250 mm	tk 775-4030-25 C	tk 775-4030-25 CS	tk 775-4030-25
	330 mm	tk 775-4030 C	tk 775-4030 CS	tk 775-4030
	450 mm	tk 775-4030-45 C	tk 775-4030-45 CS	tk 775-4030-45
 1:1 <b>Biopsie Stanze, gerieft mit Zahn</b> <i>Biopsy forceps, serrated with tooth</i> Pince à biopsie, striée, avec dent <i>Pinza de biopsia, estriada, con diente</i> Pinze per biopsia dentellata, con dente	250 mm	tk 775-4031-25 C	tk 775-4031-25 CS	tk 775-4031-25
	330 mm	tk 775-4031 C	tk 775-4031 CS	tk 775-4031
	450 mm	tk 775-4031-45 C	tk 775-4031-45 CS	tk 775-4031-45
 1:1 <b>Biopsie Stanze, durchschneidend</b> <i>Biopsy forceps, through cutting</i> Pince à biopsie, coupante <i>Pinza de biopsia, cortante</i> Pinze per biopsia, tagliente	250 mm	tk 775-4034-25 C	tk 775-4034-25 CS	tk 775-4034-25
	330 mm	tk 775-4034 C	tk 775-4034 CS	tk 775-4034
	450 mm	tk 775-4034-45 C	tk 775-4034-45 CS	tk 775-4034-45
 1:1 <b>Biopsie Stanze</b> <i>Biopsy forceps</i> Pince à biopsie <i>Pinza de biopsia</i> Pinze per biopsia	250 mm	tk 775-4033-25 C	tk 775-4033-25 CS	tk 775-4033-25
	330 mm	tk 775-4033 C	tk 775-4033 CS	tk 775-4033
	450 mm	tk 775-4033-45 C	tk 775-4033-45 CS	tk 775-4033-45
 1:1 <b>Biopsie Stanze mit Zahn</b> <i>Biopsy forceps with tooth</i> Pince à biopsie, avec dent <i>Pinza de biopsia, con diente</i> Pinze per biopsia, con dente	250 mm	tk 775-4032-25 C	tk 775-4032-25 CS	tk 775-4032-25
	330 mm	tk 775-4032 C	tk 775-4032 CS	tk 775-4032
	450 mm	tk 775-4032-45 C	tk 775-4032-45 CS	tk 775-4032-45
 1:1 <b>Löffelzange</b> <i>Spoon-forceps</i> Pince à cuillère <i>Pinza de cuchara</i> Pinza a cucchiaio	250 mm	tk 775-4245-25 C	tk 775-4245-25 CS	tk 775-4245-25
	330 mm	tk 775-4245 C	tk 775-4245 CS	tk 775-4245
	450 mm	tk 775-4245-45 C	tk 775-4245-45 CS	tk 775-4245-45
 1:1 <b>Alligator-Biopsie-Fasszange</b> <i>Alligator-biopsy-forceps</i> Pince à biopsie, crocodile <i>Pinza de biopsia, cocodrilo</i> Morso alligatore	250 mm	tk 775-4066-25 C	tk 775-4066-25 CS	tk 775-4066-25
	330 mm	tk 775-4066 C	tk 775-4066 CS	tk 775-4066
	450 mm	tk 775-4066-45 C	tk 775-4066-45 CS	tk 775-4066-45

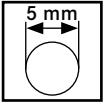

Fasszangen, zerlegbar  
*Grasping forceps, detachable*

Pincès à saisir, démontables  
*Pinzas de agarre, desmontables*  
Pinze da presa, smontabili



ohne Sperre  
*without ratchet*  
sans crémaillère  
*sin cremallera*  
senza cremagliera

mit Sperre  
*with ratchet*  
avec crémaillère  
*con cremallera*  
con cremagliera

Einsatz allein  
*Insert only*  
Insert seul  
*Inserto solo*  
Inserto, solo

**TEKNOLINE**

		Ø 5.0 mm	Ø 5.0 mm	Ø 5.0 mm		
<p>1:1</p>	<b>Dissektor, kurz, gezahnt</b> <i>Dissecting forceps, short serrated</i> Dissecteur court, dentelé <i>Disectora corta, dentada</i> Pinza per dissezione corta, zigrinata	250 mm 330 mm 450 mm	tk 775-4086-25 C tk 775-4086 C tk 775-4086-45 C	tk 775-4086-25 CS tk 775-4086 CS tk 775-4086-45 CS	tk 775-4086-25 tk 775-4086 tk 775-4086-45	
	<p>1:1</p>	<b>PETELIN Dissektor, leicht gebogen</b> <i>PETELIN dissecting forceps, slightly curved</i> PETELIN dissecteur, légèrement courbé <i>PETELIN disectora, ligeramente curvo</i> PETELIN pinza per dissezione corta, leggermente curva	250 mm 330 mm 450 mm	tk 775-4084-25 C tk 775-4084 C tk 775-4084-45 C	tk 775-4084-25 CS tk 775-4084 CS tk 775-4084-45 CS	tk 775-4084-25 tk 775-4084 tk 775-4084-45
		<p>1:1</p>	<b>PETELIN Dissektor, stark gebogen</b> <i>PETELIN dissecting forceps, strong curved</i> PETELIN dissecteur, fortement courbé <i>PETELIN disectora, fuertemente curva</i> PETELIN pinza per dissezione corta, fortemente curva	250 mm 330 mm 450 mm	tk 775-4083-25 C tk 775-4083 C tk 775-4083-45 C	tk 775-4083-25 CS tk 775-4083 CS tk 775-4083-45 CS
<p>1:1</p>			<b>Dissektor, kurz gebogen, gezahnt</b> <i>Dissecting forceps, short curved, serrated</i> Dissecteur court, dentelé, courbe <i>Disectora corta, dentada, curvada</i> Pinza per dissezione corta, curva, zigrinata	250 mm 330 mm 450 mm	tk 775-4085-25 C tk 775-4085 C tk 775-4085-45 C	tk 775-4085-25 CS tk 775-4085 CS tk 775-4085-45 CS
	<p>1:1</p>		<b>Fasszange wellenförmig</b> <i>Grasping forceps, waved</i> Pince à saisir, ondulée <i>Pinza de agarre, ondulada</i> Pinza da presa, ondulata	250 mm 330 mm 450 mm	tk 775-4062-25 C tk 775-4062 C tk 775-4062-45C	tk 775-4062-25 CS tk 775-4062 CS tk 775-4062-45CS
		<p>1:1</p>	<b>JOHAN, 20 mm, gezahntes Maul</b> <i>JOHAN, 20mm, serrated jaws</i> JOHAN, 20mm, dentelée <i>JOHAN, 20mm, dentada</i> JOHAN, 20 mm, morso zigrinato	250 mm 330 mm 450 mm	tk 775-4096-25 C tk 775-4096 C tk 775-4096-45 C	tk 775-4096-25 CS tk 775-4096 CS tk 775-4096-45 CS
<p>1:1</p>			<b>JOHAN 45 mm, gezahntes Maul</b> <i>JOHAN 45 mm, serrated jaws</i> JOHAN, 45mm, dentelée <i>JOHAN, 45mm, dentada</i> JOHAN, 45 mm, morso zigrinato	250 mm 330 mm 450 mm	tk 775-4097-25 C tk 775-4097 C tk 775-4097-45 C	tk 775-4097-25 CS tk 775-4097 CS tk 775-4097-45 CS
	<p>1:1</p>		<b>KOCHER Fasszange, 2x1 Zähne</b> <i>KOCHER Grasping forceps, 2x1 teeth</i> KOCHER pince, 2 x 1 dents <i>KOCHER pinza, 2 x 1 dientes</i> KOCHER pinza da presa, 2x1 denti	250 mm 330 mm 450 mm	tk 775-4087-25 C tk 775-4087 C tk 775-4087-45 C	tk 775-4087-25 CS tk 775-4087 CS tk 775-4087-45 CS

Fasszangen, zerlegbar  
Grasping forceps, detachable

Pinces à saisir, démontables  
Pinzas de agarre, desmontables  
Pinze da presa, smontabili

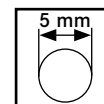

ohne Sperre  
without ratchet

sans crémaillère  
sin cremallera  
senza cremagliera







mit Sperre  
with ratchet

avec crémaillère  
con cremallera  
con cremagliera

Einsatz allein  
Insert only

Insert seul  
Inserto solo  
Inserto, solo

**TEKNOLINE**

		Ø 5.0 mm	Ø 5.0 mm	Ø 5.0 mm	
 <p>1:1</p>	Needle nose Fasszange Needle nose grasping forceps	250 mm	tk 775-4082-25 C	tk 775-4082-25 CS	tk 775-4082-25
	Pince Needle Nose	330 mm	tk 775-4082 C	tk 775-4082 CS	tk 775-4082
	Pinza Needle Nose	450 mm	tk 775-4082-45 C	tk 775-4082-45 CS	tk 775-4082-45
	Pinza da presa, piatte				
 <p>1:1</p>	Krallengreifer Claw grasping forceps	250 mm	tk 775-4243-25 C	tk 775-4243-25 CS	tk 775-4243-25
	Pince à griffes	330 mm	tk 775-4243 C	tk 775-4243 CS	tk 775-4243
	Pinza de garras	450 mm	tk 775-4243-45 C	tk 775-4243-45 CS	tk 775-4243-45
	Pinza per estrazione				
 <p>1:1</p>	Retraktionszange, atraumatisch Retraction forceps, atraumatic inner teeth	250 mm	tk 775-4093-25 C	tk 775-4093-25 CS	tk 775-4093-25
	Retracteur atraumatique	330 mm	tk 775-4093 C	tk 775-4093 CS	tk 775-4093
	Retractor atraumatico	450 mm	tk 775-4093-45 C	tk 775-4093-45 CS	tk 775-4093-45
	Pinza per estrazione				
 <p>1:1</p>	JOHAN, 17mm, gezahntes Maul, doppelbeweglich JOHAN, 17mm, serrated jaws, double action	250 mm	tk 775-4119-25 C	tk 775-4119-25 CS	tk 775-4119-25
	JOHAN, 17mm, mors dentelee, double action	330 mm	tk 775-4119 C	tk 775-4119 CS	tk 775-4119
	JOHAN, 17mm, estriada boca, doble acción	450 mm	tk 775-4119-45 C	tk 775-4119-45 CS	tk 775-4119-45
	JOHAN, 17mm, morso zigrinato, doppia azione				
 <p>1:1</p>	JOHAN, 20mm, gezahntes Maul, doppelbeweglich JOHAN, 20mm, serrated jaws, double action	250 mm	tk 775-4120-25 C	tk 775-4120-25 CS	tk 775-4120-25
	JOHAN, 20mm, mors dentelee, double action	330 mm	tk 775-4120 C	tk 775-4120 CS	tk 775-4120
	JOHAN, 20mm, estriada boca, doble acción	450 mm	tk 775-4120-45 C	tk 775-4120-45 CS	tk 775-4120-45
	JOHAN, 20mm, morso zigrinato, doppia azione				
 <p>1:1</p>	JOHAN, 25mm, gezahntes Maul, doppelbeweglich JOHAN, 25mm, serrated jaws, double action	250 mm	tk 775-4121-25 C	tk 775-4121-25 CS	tk 775-4121-25
	JOHAN, 25mm, mors dentelee, double action	330 mm	tk 775-4121 C	tk 775-4121 CS	tk 775-4121
	JOHAN, 25mm, estriada boca, doble acción	450 mm	tk 775-4121-45 C	tk 775-4121-45 CS	tk 775-4121-45
	JOHAN, 25mm, morso zigrinato, doppia azione				



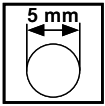

Fasszangen, zerlegbar  
*Grasping forceps, detachable*

Pincès à saisir, démontables  
*Pinzas de agarre, desmontables*  
Pinze da presa, smontabili











ohne Sperre  
*without ratchet*  
sans crémaillère  
*sin cremallera*  
senza cremagliera

mit Sperre  
*with ratchet*  
avec crémaillère  
*con cremallera*  
con cremagliera

Einsatz allein  
*Insert only*  
Insert seul  
*Inserto solo*  
Inserto, solo

**TEKNOLINE**

		Ø 5.0 mm	Ø 5.0 mm	Ø 5.0 mm			
 <p>1:1</p>	<b>DUCKBILL Fasszange</b> <i>DUCKBILL grasping forceps,</i> DUCKBILL pince, <i>DUCKBILL pinza,</i> DUCKBILL pinza da presa	250 mm 330 mm 450 mm	tk 775-4095-25 C tk 775-4095 C tk 775-4095-45 C	tk 775-4095-25 CS tk 775-4095 CS tk 775-4095-45 CS	tk 775-4095-25 tk 775-4095 tk 775-4095-45		
	 <p>1:1</p>	<b>Fasszange, gerieft</b> <i>Grasping forceps, serrated</i> Pince strié <i>Pinza estriada</i> Pinza da presa zigrinata	250 mm 330 mm 450 mm	tk 775-4036-25 C tk 775-4036 C tk 775-4036-45 C	tk 775-4036-25 CS tk 775-4036 CS tk 775-4036-45 CS	tk 775-4036-25 tk 775-4036 tk 775-4036-45	
		 <p>1:1</p>	<b>Fasszange, gerieft</b> <i>Grasping forceps, serrated</i> Pince strié <i>Pinza estriada</i> Pinza da presa zigrinata	250 mm 330 mm 450 mm	tk 775-4067-25 C tk 775-4067 C tk 775-4067-45 C	tk 775-4067-25 CS tk 775-4067 CS tk 775-4067-45 CS	tk 775-4067-25 tk 775-4067 tk 775-4067-45
			 <p>1:1</p>	<b>KELLY Fasszange</b> <i>KELLY grasping forceps</i> KELLY, pince à saisir <i>KELLY, pinza de agarre</i> KELLY, pinza da presa	250 mm 330 mm 450 mm	tk 775-4094-25 C tk 775-4094 C tk 775-4094-45 C	tk 775-4094-25 CS tk 775-4094 CS tk 775-4094-45 CS
 <p>1:1</p>				<b>Fasszange mit Reservoir, spitz</b> <i>Grasping forceps with cup, pointed</i> Pince avec cuillère, pointu <i>Pinza con cuchara, aguda</i> Pinza da presa con cucchiaio, acuta	250 mm 330 mm 450 mm	tk 775-4063-25 C tk 775-4063 C tk 775-4063-45 C	tk 775-4063-25 CS tk 775-4063 CS tk 775-4063-45 CS
	 <p>1:1</p>			<b>Fasszange mit Reservoir</b> <i>Grasping forceps with cup</i> Pince avec cuillère <i>Pinza con cuchara</i> Pinza da presa con cucchiaio	250 mm 330 mm 450 mm	tk 775-4038-25 C tk 775-4038 C tk 775-4038-45 C	tk 775-4038-25 CS tk 775-4038 CS tk 775-4038-45 CS
		 <p>1:1</p>		<b>Fasszange mit Delphin Nase, kurz</b> <i>Dolphin-nose forceps, short</i> Pince à nez du dauphin, court <i>Pinza nariz de delfín, corta</i> Pinza da presa forma naso di delfino, corta	250 mm 330 mm 450 mm	tk 775-4037-25 C tk 775-4037 C tk 775-4037-45 C	tk 775-4037-25 CS tk 775-4037 CS tk 775-4037-45 CS
			 <p>1:1</p>	<b>Fasszange gebogen</b> <i>Grasping forceps, curved</i> Pince, courbe <i>Pinza, curva</i> Pinza da presa, curva	250 mm 330 mm 450 mm	tk 775-4080-25 C tk 775-4080 C tk 775-4080-45 C	tk 775-4080-25 CS tk 775-4080 CS tk 775-4080-45 CS

Fasszangen, zerlegbar  
*Grasping forceps, detachable*

Pinces à saisir, démontables  
*Pinzas de agarre, desmontables*  
Pinze da presa, smontabili

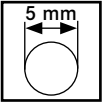

ohne Sperre  
*without ratchet*  
sans crémaillère  
*sin cremallera*  
senza cremagliera

mit Sperre  
*with ratchet*  
avec crémaillère  
*con cremallera*  
con cremagliera

Einsatz allein  
*Insert only*  
Insert seul  
*Inserto solo*  
Inserto, solo

**TEKNOLINE**

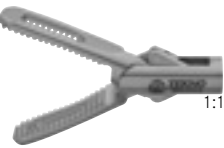
		Ø 5.0 mm	Ø 5.0 mm	Ø 5.0 mm	
 <p>1:1</p>	<b>Fasszange, gerieft</b> <i>Grasping forceps, serrated</i>	250 mm	tk 775-4225-25 C	tk 775-4225-25 CS	tk 775-4225-25
	Pince strié	330 mm	tk 775-4225 C	tk 775-4225 CS	tk 775-4225
	Pinza estriada	450 mm	tk 775-4225-45 C	tk 775-4225-45 CS	tk 775-4225-45
	Pinza da presa zirinata				
 <p>1:1</p>	<b>Multiple Fasszange</b> <i>Multiple grasping forceps</i>	250 mm	tk 775-4090-25 C	tk 775-4090-25 CS	tk 775-4090-25
	Pince strié, multiple	330 mm	tk 775-4090 C	tk 775-4090 CS	tk 775-4090
	Pinza estriada, multiple	450 mm	tk 775-4090-45 C	tk 775-4090-45 CS	tk 775-4090-45
	Pinza da presa universale				
 <p>1:1</p>	<b>Fasszange glatt</b> <i>Forceps smooth</i>	250 mm	tk 775-4035-25 C	tk 775-4035-25 CS	tk 775-4035-25
	Pince lisse	330 mm	tk 775-4035 C	tk 775-4035 CS	tk 775-4035
	Pinza lisa	450 mm	tk 775-4035-45 C	tk 775-4035-45 CS	tk 775-4035-45
	Pinza da presa liscia				
 <p>1:1</p>	<b>FUNDUS Fasszange mit Zähnen</b> <i>FUNDUS grasping forceps with teeth</i>	250 mm	tk 775-4074-25 C	tk 775-4074-25 CS	tk 775-4074-25
	FUNDUS pince, dentelé	330 mm	tk 775-4074 C	tk 775-4074 CS	tk 775-4074
	FUNDUS pinza, dentada	450 mm	tk 775-4074-45 C	tk 775-4074-45 CS	tk 775-4074-45
	FUNDUS pinza da presa zigrinata				
 <p>1:1</p>	<b>Fasszange, lang</b> <i>Grasping forceps, long</i>	250 mm	tk 775-4076-25 C	tk 775-4076-25 CS	tk 775-4076-25
	Mors longue	330 mm	tk 775-4076 C	tk 775-4076 CS	tk 775-4076
	Boca larga	450 mm	tk 775-4076-45 C	tk 775-4076-45 CS	tk 775-4076-45
	Pinza da presa, lunga				
 <p>1:1</p>	<b>Mini Fasszange, gefenstert</b> <i>Mini grasping forceps, fenestrated</i>	250 mm	tk 775-4079-25 C	tk 775-4079-25 CS	tk 775-4079-25
	Mors mini, fenêtré	330 mm	tk 775-4079 C	tk 775-4079 CS	tk 775-4079
	Boca mini, fenestrada	450 mm	tk 775-4079-45 C	tk 775-4079-45 CS	tk 775-4079-45
	Pinza da presa mini, fenestrata				
 <p>1:1</p>	<b>Fasszange gerieft, gefenstert</b> <i>Grasping forceps, serrated with window</i>	250 mm	tk 775-4068-25 C	tk 775-4068-25 CS	tk 775-4068-25
	Mors strié, fenêtré	330 mm	tk 775-4068 C	tk 775-4068 CS	tk 775-4068
	Boca estriada, fenestrada	450 mm	tk 775-4068-45 C	tk 775-4068-45 CS	tk 775-4068-45
	Pinza da presa zigrinata, fenestrata				
 <p>1:1</p>	<b>Fasszange mit starker Zahnung</b> <i>Grasping forceps, strong teeth</i>	250 mm	tk 775-4081-25 C	tk 775-4081-25 CS	tk 775-4081-25
	Mors fortement strié	330 mm	tk 775-4081 C	tk 775-4081 CS	tk 775-4081
	Boca fuertemente estriada	450 mm	tk 775-4081-45 C	tk 775-4081-45 CS	tk 775-4081-45
	Pinza da presa con dentatura robusta				

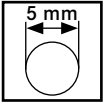

Fasszangen, zerlegbar  
Grasping forceps, detachable

Pincès à saisir, démontables  
Pinzas de agarre, desmontables  
Pinze da presa, smontabili



ohne Sperre  
without ratchet  
sans crémaillère  
sin cremallera  
senza cremagliera

mit Sperre  
with ratchet  
avec crémaillère  
con cremallera  
con cremagliera

Einsatz allein  
Insert only  
Insert seul  
Inserto solo  
Inserto, solo

**TEKNOLINE**

		Ø 5.0 mm	Ø 5.0 mm	Ø 5.0 mm
<p>1:1</p>	DEBAKEY, atraumatisch, 20 mm lang DEBAKEY, atraumatic, 20mm jaw length	250 mm	tk 775-4099-25 C	tk 775-4099-25 CS
	DEBAKEY, atraumatique, 20 mm DEBAKEY, atraumatica, 20 mm	330 mm	tk 775-4099 C	tk 775-4099 CS
	DEBAKEY atraumatica, morso lungo 20 mm	450 mm	tk 775-4099-45 C	tk 775-4099-45 CS
				tk 775-4099-25
<p>1:1</p>	DEBAKEY, atraumatisch, 30 mm lang DEBAKEY, atraumatic, 30 mm jaw length	250 mm	tk 775-4100-25 C	tk 775-4100-25 CS
	DEBAKEY, atraumatique, 30 mm DEBAKEY, atraumatica, 30 mm	330 mm	tk 775-4100 C	tk 775-4100 CS
	DEBAKEY atraumatica, morso lungo 30 mm	450 mm	tk 775-4100-45 C	tk 775-4100-45 CS
				tk 775-4100-25
<p>1:1</p>	DEBAKEY, atraumatisch, 40 mm lang DEBAKEY, atraumatic, 40 mm jaw length	250 mm	tk 775-4101-25 C	tk 775-4101-25 CS
	DEBAKEY, atraumatique, 40 mm DEBAKEY, atraumatica, 40 mm	330 mm	tk 775-4101 C	tk 775-4101 CS
	DEBAKEY atraumatica, morso lungo 40 mm	450 mm	tk 775-4101-45 C	tk 775-4101-45 CS
				tk 775-4101-25
<p>1:1</p>	DEBAKEY, atraumatisch, 50 mm lang DEBAKEY, atraumatic, 50 mm jaw length	250 mm	tk 775-4249-25 C	tk 775-4249-25 CS
	DEBAKEY, atraumatique, 50 mm DEBAKEY, atraumatica, 50 mm	330 mm	tk 775-4249 C	tk 775-4249 CS
	DEBAKEY atraumatica, morso lungo 50 mm	450 mm	tk 775-4249-45 C	tk 775-4249-45 CS
				tk 775-4249-25
<p>1:1</p>	KOCHER, längs gerieft, 40 mm lang KOCHER, lengthwise serrated, 40 mm length	250 mm	tk 775-4236-25 C	tk 775-4236-25 CS
	KOCHER, strié le long du mors, 40mm KOCHER, estriada lo larga de la boca, 40mm	330 mm	tk 775-4236 C	tk 775-4236 CS
	KOCHER, zigrinatura longitudinale, 40 mm	450 mm	tk 775-4236-45 C	tk 775-4236-45 CS
				tk 775-4236-25
<p>1:1</p>	KOCHER, längs gerieft, 60 mm lang KOCHER, lengthwise serrated, 60 mm length	250 mm	tk 775-4235-25 C	tk 775-4235-25 CS
	KOCHER, strié le long du mors, 60mm KOCHER, estriada lo larga de la boca, 60mm	330 mm	tk 775-4235 C	tk 775-4235 CS
	KOCHER, zigrinatura longitudinale, 60 mm	450 mm	tk 775-4235-45 C	tk 775-4235-45 CS
				tk 775-4235-25
<p>1:1</p>	Starke Fasszange, atraumatisch Strong grasping forceps, atraumatic	250 mm	tk 775-4232-25 C	tk 775-4232-25 CS
	Pince forte, atraumatique	330 mm	tk 775-4232 C	tk 775-4232 CS
	Pinza fuerte, atraumatica	450 mm	tk 775-4232-45 C	tk 775-4232-45 CS
	Pinza da presa molto forte, atraumatica			tk 775-4232-25
<p>1:1</p>	GLASSMANN, Fasszange, atraumatisch GLASSMANN, grasping forceps, atraumatic	250 mm	tk 775-4091-25 C	tk 775-4091-25 CS
	GLASSMANN, atraumatique	330 mm	tk 775-4091 C	tk 775-4091 CS
	GLASSMANN, atraumatica	450 mm	tk 775-4091-45 C	tk 775-4091-45 CS
	GLASSMANN, pinza da presa atraumatica			tk 775-4091-25



Fasszangen, zerlegbar  
Grasping forceps, detachable

Pinces à saisir, démontables  
Pinzas de agarre, desmontables  
Pinze da presa, smontabili

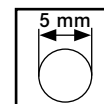





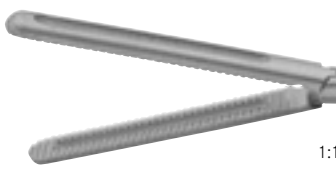
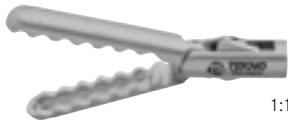

ohne Sperre  
without ratchet  
sans crémaillère  
sin cremallera  
senza cremagliera

mit Sperre  
with ratchet  
avec crémaillère  
con cremallera  
con cremagliera

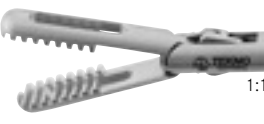
Einsatz allein  
Insert only  
Insert seul  
Inserto solo  
Inserto, solo

TEKNOLINE

		Ø 5.0 mm	Ø 5.0 mm	Ø 5.0 mm			
 <p>FUNDUS Fasszange FUNDUS grasping forceps FUNDUS, pince à saisir FUNDUS, pinza de agarre FUNDUS, pinza da presa</p>	1:1	250 mm 330 mm 450 mm	tk 775-4073-25 C tk 775-4073 C tk 775-4073-45 C	tk 775-4073-25 CS tk 775-4073 CS tk 775-4073-45 CS	tk 775-4073-25 tk 775-4073 tk 775-4073-45		
	 <p>Fasszange gewellt, mit Löffel Grasping forceps, waved with pocket Mors ondulé, avec cuillère Boca ondulada, con cuchara Pinza da presa ondulata, con cucchiaio</p>	1:1	250 mm 330 mm 450 mm	tk 775-4072-25 C tk 775-4072 C tk 775-4072-45 C	tk 775-4072-25 CS tk 775-4072 CS tk 775-4072-45 CS	tk 775-4072-25 tk 775-4072 tk 775-4072-45	
		 <p>ENDO CLINCH, atraumatisch gezahnt ENDO CLINCH, atraumatic serrated ENDO CLINCH, atraumatique, dentelé ENDO CLINCH, atraumatica, dentada ENDO CLINCH, atraumatica dentata</p>	1:1	250 mm 330 mm 450 mm	tk 775-4089-25 C tk 775-4089 C tk 775-4089-45 C	tk 775-4089-25 CS tk 775-4089 CS tk 775-4089-45 CS	tk 775-4089-25 tk 775-4089 tk 775-4089-45
			 <p>ENDO CLINCH, atraumatisch gezahnt, fein ENDO CLINCH, atraumatic serrated, fein ENDO CLINCH, atraumatique, dentelé, fin ENDO CLINCH, atraumatica, dentada, fina ENDO CLINCH, atraumatica dentata, fine</p>	1:1	250 mm 330 mm 450 mm	tk 775-4053-25 C tk 775-4053 C tk 775-4053-45 C	tk 775-4053-25 CS tk 775-4053 CS tk 775-4053-45 CS
 <p>Fasszange, 2x4 gezahnt Grasping forceps, 2x4 teeth Pince à saisir, 2x4 dents Pinza de agarre, 2x4 dientes Pinza da presa, 2x4 denti</p>	1:1			250 mm 330 mm 450 mm	tk 775-4065-25 C tk 775-4065 C tk 775-4065-45 C	tk 775-4065-25 CS tk 775-4065 CS tk 775-4065-45 CS	tk 775-4065-25 tk 775-4065 tk 775-4065-45
	 <p>Fasszange mit 4x5 Zähnen, glatt Grasping forceps, 4x5 teeth, smooth Pince à saisir, 4x5 dents, lisse Pinza de agarre, 4x5 dientes, lisa Pinza da presa, 4x5 denti, liscia</p>	1:1		250 mm 330 mm 450 mm	tk 775-4078-25 C tk 775-4078 C tk 775-4078-45 C	tk 775-4078-25 CS tk 775-4078 CS tk 775-4078-45 CS	tk 775-4078-25 tk 775-4078 tk 775-4078-45
		 <p>SCHROEDER Hakenzange, 1x1 Zähne, scharf SCHROEDER, hook forceps, sharp teeth SCHROEDER, pince à crochet, pointue SCHROEDER, pinza de gancho, aguda SCHROEDER pinza ad uncino, 1x1 denti, acuta</p>	1:1	250 mm 330 mm 450 mm	tk 775-4244-25 C tk 775-4244 C tk 775-4244-45 C	tk 775-4244-25 CS tk 775-4244 CS tk 775-4244-45 CS	tk 775-4244-25 tk 775-4244 tk 775-4244-45
 <p>Knotenschnürer Knot tier Pince pousse noeuds Pinza baja nudo Pinza spingi nodo</p>			1:1	250 mm 330 mm 450 mm	tk 704-109-25 C tk 704-109 C tk 704-109-45 C	tk 704-109-25 CS tk 704-109 CS tk 704-109-45 CS	tk 704-109-25 tk 704-109 tk 704-109-45

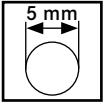

Fasszangen, zerlegbar  
*Grasping forceps, detachable*

Pincès à saisir, démontables  
*Pinzas de agarre, desmontables*  
Pinze da presa, smontabili









ohne Sperre  
*without ratchet*  
sans crémaillère  
*sin cremallera*  
senza cremagliera

mit Sperre  
*with ratchet*  
avec crémaillère  
*con cremallera*  
con cremagliera

Einsatz allein  
*Insert only*  
Insert seul  
*Inserto solo*  
Inserto, solo

**TEKNO**LINE

		Ø 5.0 mm	Ø 5.0 mm	Ø 5.0 mm			
 <p>1:1</p>	<b>Fasszange, atraumatisch, spitz</b> <i>Grasping forceps pointed, atraumatic</i> Pince à saisir, atraumatique, pointu <i>Pinza de agarre, atraumatica, aguda</i> Pinza da presa atraumatica, acuta	250 mm 330 mm 450 mm	tk 775-4064-25 C tk 775-4064 C tk 775-4064-45 C	tk 775-4064-25 CS tk 775-4064 CS tk 775-4064-45 CS	tk 775-4064-25 tk 775-4064 tk 775-4064-45		
	 <p>1:1</p>	<b>MARYLAND Fasszange, grob gerieft, gebogen</b> <i>MARYLAND coarse serrated, curved</i> MARYLAND, strié fort, courbe <i>MARYLAND, estriada fuerte, curva</i> MARYLAND, zigrinatura larga, curva	250 mm 330 mm 450 mm	tk 775-4069-25 C tk 775-4069 C tk 775-4069-45 C	tk 775-4069-25 CS tk 775-4069 CS tk 775-4069-45 CS	tk 775-4069-25 tk 775-4069 tk 775-4069-45	
		 <p>1:1</p>	<b>MARYLAND Fasszange, fein gerieft, gebogen</b> <i>MARYLAND grasping forceps, fine serrated</i> MARYLAND, strié fin <i>MARYLAND, estriada fina</i> MARYLAND, pinza da presa, zigrinatura fine	250 mm 330 mm 450 mm	tk 775-4021-25 C tk 775-4021 C tk 775-4021-45 C	tk 775-4021-25 CS tk 775-4021 CS tk 775-4021-45 CS	tk 775-4021-25 tk 775-4021 tk 775-4021-45
			 <p>1:1</p>	<b>MARYLAND, kreuzgerieft</b> <i>MARYLAND, cross serrated</i> MARYLAND, strié en cruciforme <i>MARYLAND, estriada en cruciforma</i> MARYLAND, zigrinatura a croce	250 mm 330 mm 450 mm	tk 775-4075-25 C tk 775-4075 C tk 775-4075-45 C	tk 775-4075-25 CS tk 775-4075 CS tk 775-4075-45 CS
 <p>1:1</p>				<b>MARYLAND, DEBAKEY, gebogen</b> <i>MARYLAND, DEBAKEY, curved</i> MARYLAND, DEBAKEY, courbe <i>MARYLAND, DEBAKEY, curva</i> MARYLAND, DEBAKEY, curva	250 mm 330 mm 450 mm	tk 775-4088-25 C tk 775-4088 C tk 775-4088-45 C	tk 775-4088-25 CS tk 775-4088 CS tk 775-4088-45 CS
	 <p>1:1</p>			<b>MIXTER Fasszange, 45° gewinkelt</b> <i>MIXTER grasping forceps, 45° angled</i> MIXTER, 45° angulé <i>MIXTER, 45° angulada</i> MIXTER, pinza da presa angolata a 45°	250 mm 330 mm 450 mm	tk 775-4228-25 C tk 775-4228 C tk 775-4228-45 C	tk 775-4228-25 CS tk 775-4228 CS tk 775-4228-45 CS
		 <p>1:1</p>		<b>MIXTER Fasszange, 45° gebogen</b> <i>MIXTER grasping forceps, 45° curved</i> MIXTER, 45° courbé <i>MIXTER, 45° curvada</i> MIXTER, pinza da presa curva a 45°	250 mm 330 mm 450 mm	tk 775-4222-25 C tk 775-4222 C tk 775-4222-45 C	tk 775-4222-25 CS tk 775-4222 CS tk 775-4222-45 CS

Fasszangen, zerlegbar  
Grasping forceps, detachable

Pinces à saisir, démontables  
Pinzas de agarre, desmontables  
Pinze da presa, smontabili

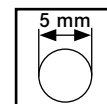







ohne Sperre  
without ratchet  
sans crémaillère  
sin cremallera  
senza cremagliera

mit Sperre  
with ratchet  
avec crémaillère  
con cremallera  
con cremagliera

Einsatz allein  
Insert only  
Insert seul  
Inserto solo  
Inserto, solo

TEKNO LINE

		Ø 5.0 mm	Ø 5.0 mm	Ø 5.0 mm
 <p>MIXTER Fasszange, 90° gewinkelt MIXTER grasping forceps, 90° angled 1:1 MIXTER, 90° angulé MIXTER, 90° angulada MIXTER, pinza da presa angolata a 90°</p>	250 mm	tk 775-4092-25 C	tk 775-4092-25 CS	tk 775-4092-25
	330 mm	tk 775-4092 C	tk 775-4092 CS	tk 775-4092
	450 mm	tk 775-4092-45 C	tk 775-4092-45 CS	tk 775-4092-45
 <p>COLLIN Fasszange COLLIN grasping forceps 1:1 COLLIN pince à saisir COLLIN pinza de agarre COLLIN pinza da presa</p>	250 mm	tk 775-4246-25 C	tk 775-4246-25 CS	tk 775-4246-25
	330 mm	tk 775-4246 C	tk 775-4246 CS	tk 775-4246
	450 mm	tk 775-4246-45 C	tk 775-4246-45 CS	tk 775-4246-45
 <p>DUVAL, Fasszange DUVAL grasping forceps 1:1 DUVAL pince à saisir DUVAL pinza de agarre DUVAL pinza da presa</p>	250 mm	tk 775-4233-25 C	tk 775-4233-25 CS	tk 775-4233-25
	330 mm	tk 775-4233 C	tk 775-4233 CS	tk 775-4233
	450 mm	tk 775-4233-45 C	tk 775-4233-45 CS	tk 775-4233-45
 <p>TC-COLLIN Fasszange, kreuzgerieft TC-COLLIN grasping forceps, cross serrated 1:1 TC-COLLIN pince à saisir, strié TC-COLLIN pinza de agarre, estriada TC-COLLIN pinza da presa zigrinata a croce</p>	250 mm	tk 775-4234-25 C	tk 775-4234-25 CS	tk 775-4234-25
	330 mm	tk 775-4234 C	tk 775-4234 CS	tk 775-4234
	450 mm	tk 775-4234-45 C	tk 775-4234-45 CS	tk 775-4234-45
 <p>PENNINGTON Fasszange PENNINGTON grasping forceps 1:1 PENNINGTON pince à saisir PENNINGTON pinza de agarre PENNINGTON pinza da presa</p>	250 mm	tk 775-4224-25 C	tk 775-4224-25 CS	tk 775-4224-25
	330 mm	tk 775-4224 C	tk 775-4224 CS	tk 775-4224
	450 mm	tk 775-4224-45 C	tk 775-4224-45 CS	tk 775-4224-45
 <p>BABCOCK Fasszange BABCOCK-forceps 1:1 BABCOCK pince à saisir BABCOCK pinza de agarre BABCOCK pinza da presa</p>	250 mm	tk 775-4098-25 C	tk 775-4098-25 CS	tk 775-4098-25
	330 mm	tk 775-4098 C	tk 775-4098 CS	tk 775-4098
	450 mm	tk 775-4098-45 C	tk 775-4098-45 CS	tk 775-4098-45
 <p>ALLIS Fasszange ALLIS grasping forceps 1:1 ALLIS pince à saisir ALLIS pinza de agarre ALLIS pinza da presa</p>	250 mm	tk 775-4229-25 C	tk 775-4229-25 CS	tk 775-4229-25
	330 mm	tk 775-4229 C	tk 775-4229 CS	tk 775-4229
	450 mm	tk 775-4229-45 C	tk 775-4229-45 CS	tk 775-4229-45

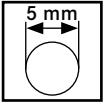

Fasszangen, zerlegbar  
*Grasping forceps, detachable*

Pincès à saisir, démontables  
*Pinzas de agarre, desmontables*  
Pinze da presa, smontabili







ohne Sperre  
*without ratchet*  
sans crémaillère  
*sin cremallera*  
senza cremagliera

mit Sperre  
*with ratchet*  
avec crémaillère  
*con cremallera*  
con cremagliera

Einsatz allein  
*Insert only*  
Insert seul  
*Inserto solo*  
Inserto, solo

**TEKNOLINE**

		Ø 5.0 mm	Ø 5.0 mm	Ø 5.0 mm			
 <p>1:1</p>	<b>ALLIS Fasszange, kreuzgerieft</b> <i>ALLIS grasping forceps, cross serrated</i> ALLIS pince à saisir, strié transversal <i>ALLIS pinza de agarre, estriada transversal</i> ALLIS pinza da presa, zigrinatura a croce	250 mm 330 mm 450 mm	<b>tk 775-4070-25 C</b> <b>tk 775-4070 C</b> <b>tk 775-4070-45 C</b>	<b>tk 775-4070-25 CS</b> <b>tk 775-4070 CS</b> <b>tk 775-4070-45 CS</b>	<b>tk 775-4070-25</b> <b>tk 775-4070</b> <b>tk 775-4070-45</b>		
	 <p>1:1</p>	<b>DEBAKEY Fasszange, atraumatisch</b> <i>DEBAKEY grasping forceps, atraumatic</i> DEBAKEY, atraumatique <i>DEBAKEY, atraumatica</i> DEBAKEY pinza da presa atraumatica	250 mm 330 mm 450 mm	<b>tk 775-4226-25 C</b> <b>tk 775-4226 C</b> <b>tk 775-4226-45 C</b>	<b>tk 775-4226-25 CS</b> <b>tk 775-4226 CS</b> <b>tk 775-4226-45 CS</b>	<b>tk 775-4226-25</b> <b>tk 775-4226</b> <b>tk 775-4226-45</b>	
		 <p>1:1</p>	<b>ALLIS Fasszange, längsgezahnt</b> <i>ALLIS grasping forceps, lengthwise serrated</i> ALLIS pince à saisir, strié longitudinal <i>ALLIS pinza de agarre, estriada longitudinal</i> ALLIS pinza da presa, zigrinata longitudinale	250 mm 330 mm 450 mm	<b>tk 775-4071-25 C</b> <b>tk 775-4071 C</b> <b>tk 775-4071-45 C</b>	<b>tk 775-4071-25 CS</b> <b>tk 775-4071 CS</b> <b>tk 775-4071-45 CS</b>	<b>tk 775-4071-25</b> <b>tk 775-4071</b> <b>tk 775-4071-45</b>
			 <p>1:1</p>	<b>TENACULUM Hakenzange, scharf</b> <i>TENACULUM forceps, sharp</i> TENACULUM, pince à crochet, pointue <i>TENACULUM, pinza de gancho, aguda</i> TENACULUM pinza ad uncino, acuta	250 mm 330 mm 450 mm	<b>tk 775-4253-25 C</b> <b>tk 775-4253 C</b> <b>tk 775-4253-45 C</b>	<b>tk 775-4253-25 CS</b> <b>tk 775-4253 CS</b> <b>tk 775-4253-45 CS</b>

Biopsiezangen, zerlegbar  
*Biopsy forceps, detachable*

Pinces à biopsie, démontables  
*Pinzas de biopsia, desmontables*  
 Pinze per biopsia, smontabili

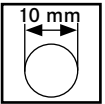





ohne Sperre  
*without ratchet*  
 sans crémaillère  
*sin cremallera*  
 senza cremagliera

mit Sperre  
*with ratchet*  
 avec crémaillère  
*con cremallera*  
 con cremagliera

Einsatz allein  
*Insert only*  
 Insert seul  
*Inserto solo*  
 Inserto, solo

**TEKNOLINE**

		Ø 10.0 mm	Ø 10.0 mm	Ø 10.0 mm			
 1:2	<b>Biopsie Stanze</b> <i>Biopsy forceps</i> Pince à biopsie <i>Pinza de biopsia</i> Pinze per biopsia	250 mm 330 mm 450 mm	tk 775-5050-25 C tk 775-5050 C tk 775-5050-45 C	tk 775-5050-25 CS tk 775-5050 CS tk 775-5050-45 CS	tk 775-5050-25 tk 775-5050 tk 775-5050-45		
	 1:2	<b>Biopsie Stanze, durchschneidend</b> <i>Biopsy forceps, through cutting</i> Pince à biopsie, coupante <i>Pinza de biopsia, cortante</i> Pinze per biopsia, taglienti	250 mm 330 mm 450 mm	tk 775-5054-25 C tk 775-5054 C tk 775-5054-45 C	tk 775-5054-25 CS tk 775-5054 CS tk 775-5054-45 CS	tk 775-5054-25 tk 775-5054 tk 775-5054-45	
		 1:2	<b>Biopsie Stanze mit Zahn</b> <i>Biopsy forceps with tooth</i> Pince à biopsie, avec dent <i>Pinza de biopsia, con diente</i> Pinze per biopsia, con dente	250 mm 330 mm 450 mm	tk 775-5052-25 C tk 775-5052 C tk 775-5052-45 C	tk 775-5052-25 CS tk 775-5052 CS tk 775-5052-45 CS	tk 775-5052-25 tk 775-5052 tk 775-5052-45
			<b>Löffelzange</b> <i>Spoon-forceps</i> Pince à cuillère <i>Pinza de cuchara</i> Pinza a cucchiaio	250 mm 330 mm 450 mm	tk 775-5045-25 C tk 775-5045 C tk 775-5045-45 C	tk 775-5045-25 CS tk 775-5045 CS tk 775-5045-45 CS	tk 775-5045-25 tk 775-5045 tk 775-5045-45
 1:2	<b>Alligator-Biopsie-Fasszange</b> <i>Alligator-biopsy-forceps</i> Pince à biopsie, crocodile <i>Pinza de biopsia, cocodrilo</i> Pinza da presa, morso alligatore	250 mm 330 mm 450 mm	tk 775-5066-25 C tk 775-5066 C tk 775-5066-45 C	tk 775-5066-25 CS tk 775-5066 CS tk 775-5066-45 CS	tk 775-5066-25 tk 775-5066 tk 775-5066-45		

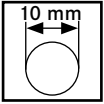

Fasszangen, zerlegbar  
*Grasping forceps, detachable*

Pincès à saisir, démontables  
*Pinzas de agarre, desmontables*  
Pinze da presa, smontabili







ohne Sperre  
*without ratchet*  
sans crémaillère  
*sin cremallera*  
senza cremagliera

mit Sperre  
*with ratchet*  
avec crémaillère  
*con cremallera*  
con cremagliera

Einsatz allein  
*Insert only*  
Insert seul  
*Inserto solo*  
Inserto, solo

**TEKNOLINE**

		Ø 10.0 mm	Ø 10.0 mm	Ø 10.0 mm	
 1:2	PETELIN Dissektor, leicht gebogen <i>PETELIN dissecting forceps, slightly curved</i>	250 mm	tk 775-5084-25 C	tk 775-5084-25 CS	tk 775-5084-25
	PETELIN dissecteur, légèrement courbé <i>PETELIN disetcora, ligeramente curvo</i>	330 mm	tk 775-5084 C	tk 775-5084 CS	tk 775-5084
	PETELIN pinza per dissezione corta, leggermente curva	450 mm	tk 775-5084-45 C	tk 775-5084-45 CS	tk 775-5084-45
 1:2	PETELIN Dissektor, stark gebogen <i>PETELIN dissecting forceps, strong curved</i>	250 mm	tk 775-5083-25 C	tk 775-5083-25 CS	tk 775-5083-25
	PETELIN dissecteur, fortement courbé <i>PETELIN disetcora, fuertemente curva</i>	330 mm	tk 775-5083 C	tk 775-5083 CS	tk 775-5083
	PETELIN pinza per dissezione corta, fortemente curva	450 mm	tk 775-5083-45 C	tk 775-5083-45 CS	tk 775-5083-45
 1:2	JOHAN, 20 mm, gezahntes Maul <i>JOHAN, 20 mm, serrated jaws</i>	250 mm	tk 775-5096-25 C	tk 775-5096-25 CS	tk 775-5096-25
	JOHAN, 20mm, dentelée <i>JOHAN, 20mm, dentada</i>	330 mm	tk 775-5096 C	tk 775-5096 CS	tk 775-5096
	JOHAN, 20 mm, morso zigrinato	450 mm	tk 775-5096-45 C	tk 775-5096-45 CS	tk 775-5096-45
 1:2	JOHAN 45 mm, gezahntes Maul <i>JOHAN 45 mm, serrated jaws</i>	250 mm	tk 775-5097-25 C	tk 775-5097-25 CS	tk 775-5097-25
	JOHAN, 45mm, dentelée <i>JOHAN, 45mm, dentada</i>	330 mm	tk 775-5097 C	tk 775-5097 CS	tk 775-5097
	JOHAN, 45 mm, morso zigrinato	450 mm	tk 775-5097-45 C	tk 775-5097-45 CS	tk 775-5097-45
 1:2	KOCHER Fasszange, 2x1 Zähne <i>KOCHER Grasping forceps, 2x1 teeth</i>	250 mm	tk 775-5087-25 C	tk 775-5087-25 CS	tk 775-5087-25
	KOCHER pinze, 2 x 1 dents <i>KOCHER pinza, 2 x 1 dientes</i>	330 mm	tk 775-5087 C	tk 775-5087 CS	tk 775-5087
	KOCHER pinza da presa, 2x1 denti	450 mm	tk 775-5087-45 C	tk 775-5087-45 CS	tk 775-5087-45



Fasszangen, zerlegbar  
Grasping forceps, detachable

Pinces à saisir, démontables  
Pinzas de agarre, desmontables  
Pinze da presa, smontabili

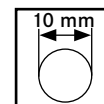

ohne Sperre  
without ratchet  
sans crémaillère  
sin cremallera  
senza cremagliera

mit Sperre  
with ratchet  
avec crémaillère  
con cremallera  
con cremagliera

Einsatz allein  
Insert only  
Insert seul  
Inserto solo  
Inserto, solo

**TEKNOLINE**



1:2

Krallengreifer  
Claw grasping forceps  
Pince à griffes  
Pinza de garras  
Pinza per estrazione

250 mm  
330 mm  
450 mm

Ø 10.0 mm

tk 775-5043-25 C  
tk 775-5043 C  
tk 775-5043-45 C

Ø 10.0 mm

tk 775-5043-25 CS  
tk 775-5043 CS  
tk 775-5043-45 CS

Ø 10.0 mm

tk 775-5043-25  
tk 775-5043  
tk 775-5043-45



1:2

Retraktionszange, atraumatisch  
Retraction forceps, atraumatic  
Retracteur atraumatique  
Retractor atraumatico  
Pinza per estrazione, atraumatica

250 mm  
330 mm  
450 mm

tk 775-5093-25 C  
tk 775-5093 C  
tk 775-5093-45 C

tk 775-5093-25 CS  
tk 775-5093 CS  
tk 775-5093-45 CS

tk 775-5093-25  
tk 775-5093  
tk 775-5093-45

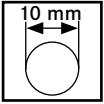

Fasszangen, zerlegbar  
Grasping forceps, detachable

Pincès à saisir, démontables  
Pinzas de agarre, desmontables  
Pinze da presa, smontabili







ohne Sperre  
without ratchet  
sans crémaillère  
sin cremallera  
senza cremagliera

mit Sperre  
with ratchet  
avec crémaillère  
con cremallera  
con cremagliera

Einsatz allein  
Insert only  
Insert seul  
Inserto solo  
Inserto, solo

**TEKNO LINE**

		Ø 10.0 mm	Ø 10.0 mm	Ø 10.0 mm
 1:2	Fasszange, gerieft Grasping forceps, serrated	250 mm	tk 775-5056-25 C	tk 775-5056-25 CS
	Pince strié	330 mm	tk 775-5056 C	tk 775-5056 CS
	Pinza estriada	450 mm	tk 775-5056-45 C	tk 775-5056-45 CS
	Pinza da presa zigrinata			tk 775-5056-45
 1:2	Fasszange, gerieft Grasping forceps, serrated	250 mm	tk 775-5067-25 C	tk 775-5067-25 CS
	Pince strié	330 mm	tk 775-5067 C	tk 775-5067 CS
	Pinza estriada	450 mm	tk 775-5067-45 C	tk 775-5067-45 CS
	Pinza da presa zigrinata			tk 775-5067-45
 1:2	KELLY Fasszange KELLY grasping forceps	250 mm	tk 775-5094-25 C	tk 775-5094-25 CS
	KELLY, pince à saisir	330 mm	tk 775-5094 C	tk 775-5094 CS
	KELLY, pinza de agarre	450 mm	tk 775-5094-45 C	tk 775-5094-45 CS
	KELLY, pinza da presa			tk 775-5094-45
 1:2	Fasszange mit Reservoir Grasping forceps with cup	250 mm	tk 775-5058-25 C	tk 775-5058-25 CS
	Pince avec cuillère	330 mm	tk 775-5058 C	tk 775-5058 CS
	Pinza con cuchara	450 mm	tk 775-5058-45 C	tk 775-5058-45 CS
	Pinza da presa con cucchiaio			tk 775-5058-45



Fasszangen, zerlegbar  
Grasping forceps, detachable

Pinces à saisir, démontables  
Pinzas de agarre, desmontables  
Pinze da presa, smontabili

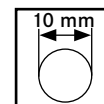

ohne Sperre  
without ratchet

mit Sperre  
with ratchet









Einsatz allein  
Insert only

sans crémaillère  
sin cremallera  
senza cremagliera

avec crémaillère  
con cremallera  
con cremagliera

Insert seul  
Inserto solo  
Inserto, solo

TEKNOLINE

		Ø 10.0 mm	Ø 10.0 mm	Ø 10.0 mm
 <p>1:2</p>	<b>Fasszange, gerieft</b> <b>Grasping forceps, serrated</b>	250 mm	tk 775-5025-25 C	tk 775-5025-25 CS
	Pince strié	330 mm	tk 775-5025 C	tk 775-5025 CS
	Pinza estriada	450 mm	tk 775-5025-45 C	tk 775-5025-45 CS
	Pinza da presa zigrinata			tk 775-5025-45
 <p>1:2</p>	<b>Multiple Fasszange</b> <b>Multiple grasping forceps</b>	250 mm	tk 775-5090-25 C	tk 775-5090-25 CS
	Pince strié, multiple	330 mm	tk 775-5090 C	tk 775-5090 CS
	Pinza estriada, multiple	450 mm	tk 775-5090-45 C	tk 775-5090-45 CS
	Pinza da presa universale			tk 775-5090-45
 <p>1:2</p>	<b>Fasszange glatt</b> <b>Forceps smooth</b>	250 mm	tk 775-5055-25 C	tk 775-5055-25 CS
	Pince lisse	330 mm	tk 775-5055 C	tk 775-5055 CS
	Pinza lisa	450 mm	tk 775-5055-45 C	tk 775-5055-45 CS
	Pinza da presa, liscia			tk 775-5055-45
 <p>1:2</p>	<b>FUNDUS Fasszange mit Zähnen</b> <b>FUNDUS grasping forceps with teeth</b>	250 mm	tk 775-5074-25 C	tk 775-5074-25 CS
	FUNDUS pince, dentelé	330 mm	tk 775-5074 C	tk 775-5074 CS
	FUNDUS pinza, dentada	450 mm	tk 775-5074-45 C	tk 775-5074-45 CS
	FUNDUS pinza da presa con denti			tk 775-5074-45
 <p>1:2</p>	<b>Fasszange, lang</b> <b>Grasping forceps, long</b>	250 mm	tk 775-5076-25 C	tk 775-5076-25 CS
	Mors longue	330 mm	tk 775-5076 C	tk 775-5076 CS
	Boca larga	450 mm	tk 775-5076-45 C	tk 775-5076-45 CS
	Pinza da presa, lunga			tk 775-5076-45
 <p>1:2</p>	<b>Mini Fasszange, gefenstert</b> <b>Mini grasping forceps, fenestrated</b>	250 mm	tk 775-5079-25 C	tk 775-5079-25 CS
	Mors mini, fenêtré	330 mm	tk 775-5079 C	tk 775-5079 CS
	Boca mini, fenestrada	450 mm	tk 775-5079-45 C	tk 775-5079-45 CS
	Pinza da presa mini, fenestrata			tk 775-5079-45
 <p>1:2</p>	<b>Fasszange gerieft, gefenstert</b> <b>Grasping forceps, serrated with window</b>	250 mm	tk 775-5068-25 C	tk 775-5068-25 CS
	Mors strié, fenêtré	330 mm	tk 775-5068 C	tk 775-5068 CS
	Boca estriada, fenestrada	450 mm	tk 775-5068-45 C	tk 775-5068-45 CS
	Pinza da presa zirinata, fenestrata			tk 775-5068-45
 <p>1:2</p>	<b>Fasszange mit starker Zahnung</b> <b>Grasping forceps, strong teeth</b>	250 mm	tk 775-5081-25 C	tk 775-5081-25 CS
	Mors fortement strié	330 mm	tk 775-5081 C	tk 775-5081 CS
	Boca fuertemente estriada	450 mm	tk 775-5081-45 C	tk 775-5081-45 CS
	Pinza da presa con dentatura forte			tk 775-5081-45

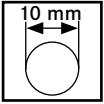

Fasszangen, zerlegbar  
Grasping forceps, detachable

Pincès à saisir, démontables  
Pinzas de agarre, desmontables  
Pinze da presa, smontabili



ohne Sperre  
*without ratchet*  
sans crémaillère  
*sin cremallera*  
senza cremagliera

mit Sperre  
*with ratchet*  
avec crémaillère  
*con cremallera*  
con cremagliera

Einsatz allein  
*Insert only*  
Insert seul  
*Inserto solo*  
Inserto, solo

**TEKNO LINE**

		Ø 10.0 mm	Ø 10.0 mm	Ø 10.0 mm
<p>1:2 DEBAKEY, atraumatisch, 20 mm lang <i>DEBAKEY, atraumatic, 20 mm jaw length</i> DEBAKEY, atraumatique, 20 mm <i>DEBAKEY, atraumatica, 20 mm</i> DEBAKEY atraumatica, morso lungo 20 mm</p>	250 mm	tk 775-5099-25 C	tk 775-5099-25 CS	tk 775-5099-25
	330 mm	tk 775-5099 C	tk 775-5099 CS	tk 775-5099
	450 mm	tk 775-5099-45 C	tk 775-5099-45 CS	tk 775-5099-45
<p>1:2 DEBAKEY, atraumatisch, 30 mm lang <i>DEBAKEY, atraumatic, 30 mm jaw length</i> DEBAKEY, atraumatique, 30 mm <i>DEBAKEY, atraumatica, 30 mm</i> DEBAKEY atraumatica, morso lungo 30 mm</p>	250 mm	tk 775-5047-25 C	tk 775-5047-25 CS	tk 775-5047-25
	330 mm	tk 775-5047 C	tk 775-5047 CS	tk 775-5047
	450 mm	tk 775-5047-45 C	tk 775-5047-45 CS	tk 775-5047-45
<p>1:2 DEBAKEY, atraumatisch, 40 mm lang <i>DEBAKEY, atraumatic, 40 mm jaw length</i> DEBAKEY, atraumatique, 40 mm <i>DEBAKEY, atraumatica, 40 mm</i> DEBAKEY atraumatica, morso lungo 40 mm</p>	250 mm	tk 775-5048-25 C	tk 775-5048-25 CS	tk 775-5048-25
	330 mm	tk 775-5048 C	tk 775-5048 CS	tk 775-5048
	450 mm	tk 775-5048-45 C	tk 775-5048-45 CS	tk 775-5048-45
<p>1:2 DEBAKEY, atraumatisch, 50 mm lang <i>DEBAKEY, atraumatic, 50 mm jaw length</i> DEBAKEY, atraumatique, 50 mm <i>DEBAKEY, atraumatica, 50 mm</i> DEBAKEY atraumatica, morso lungo 50 mm</p>	250 mm	tk 775-5049-25 C	tk 775-5049-25 CS	tk 775-5049-25
	330 mm	tk 775-5049 C	tk 775-5049 CS	tk 775-5049
	450 mm	tk 775-5049-45 C	tk 775-5049-45 CS	tk 775-5049-45
<p>1:2 KOCHER, längs gerieft, 40 mm lang <i>KOCHER, lengthwise serrated, 40 mm length</i> KOCHER, strié le long du mors, 40mm <i>KOCHER, estriada lo larga de la boca, 40mm</i> KOCHER, zigrinatura longitudinale, 40 mm</p>	250 mm	tk 775-5036-25 C	tk 775-5036-25 CS	tk 775-5036-25
	330 mm	tk 775-5036 C	tk 775-5036 CS	tk 775-5036
	450 mm	tk 775-5036-45 C	tk 775-5036-45 CS	tk 775-5036-45
<p>1:2 KOCHER, längs gerieft, 60 mm lang <i>KOCHER, lengthwise serrated, 60 mm length</i> KOCHER, strié le long du mors, 60mm <i>KOCHER, estriada lo larga de la boca, 60mm</i> KOCHER, zigrinatura longitudinale, 60 mm</p>	250 mm	tk 775-5035-25 C	tk 775-5035-25 CS	tk 775-5035-25
	330 mm	tk 775-5035 C	tk 775-5035 CS	tk 775-5035
	450 mm	tk 775-5035-45 C	tk 775-5035-45 CS	tk 775-5035-45
<p>1:2 Starke Fasszange, atraumatisch <i>Strong grasping forceps, atraumatic</i> Pince forte, atraumatique <i>Pinza fuerte, atraumatica</i> Pinza da presa molto forte, atraumatica</p>	250 mm	tk 775-5032-25 C	tk 775-5032-25 CS	tk 775-5032-25
	330 mm	tk 775-5032 C	tk 775-5032 CS	tk 775-5032
	450 mm	tk 775-5032-45 C	tk 775-5032-45 CS	tk 775-5032-45

Fasszangen, zerlegbar  
Grasping forceps, detachable

Pinces à saisir, démontables  
Pinzas de agarre, desmontables  
Pinze da presa, smontabili

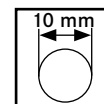





ohne Sperre  
without ratchet  
sans crémaillère  
sin cremallera  
senza cremagliera

mit Sperre  
with ratchet  
avec crémaillère  
con cremallera  
con cremagliera

Einsatz allein  
Insert only  
Insert seul  
Inserto solo  
Inserto, solo

**TEKNOLINE**

		Ø 10.0 mm	Ø 10.0 mm	Ø 10.0 mm		
 <p>1:2 FUNDUS, pince à saisir FUNDUS, pinza de agarre FUNDUS, pinza da presa</p>	<p><b>FUNDUS</b> Fasszange <b>FUNDUS</b> grasping forceps</p>	<p>250 mm tk 775-5073-25 C 330 mm tk 775-5073 C 450 mm tk 775-5073-45 C</p>	<p>tk 775-5073-25 CS tk 775-5073 CS tk 775-5073-45 CS</p>	<p>tk 775-5073-25 tk 775-5073 tk 775-5073-45</p>		
	 <p>1:2 ENDO CLINCH, atraumatich gezahnt, ENDO CLINCH, atraumatic serrated ENDO CLINCH, atraumatique, dentelé ENDO CLINCH, atraumatica, dentada ENDO CLINCH, atraumatica dentata</p>	<p><b>ENDO CLINCH</b>, atraumatic serrated</p>	<p>250 mm tk 775-5089-25 C 330 mm tk 775-5089 C 450 mm tk 775-5089-45 C</p>	<p>tk 775-5089-25 CS tk 775-5089 CS tk 775-5089-45 CS</p>	<p>tk 775-5089-25 tk 775-5089 tk 775-5089-45</p>	
		 <p>1:2 Fasszange, 2x3 gezahnt Grasping forceps, 2x3 teeth Pince à saisir, 2x3 dents Pinza de agarre, 2x3 dientes Pinza da presa, 2x3 denti</p>	<p><b>Fasszange</b>, 2x3 gezahnt <b>Grasping forceps</b>, 2x3 teeth</p>	<p>250 mm tk 775-5065-25 C 330 mm tk 775-5065 C 450 mm tk 775-5065-45 C</p>	<p>tk 775-5065-25 CS tk 775-5065 CS tk 775-5065-45 CS</p>	<p>tk 775-5065-25 tk 775-5065 tk 775-5065-45</p>
			 <p>1:2 Fasszange mit 3x4 Zähnen, glatt Grasping forceps, 3x4 teeth, smooth Pince à saisir, 3x4 dents, lisse Pinza de agarre, 3x4 dientes, lisa Pinza da presa, 3x4 denti, liscia</p>	<p><b>Fasszange</b> mit 3x4 Zähnen, glatt <b>Grasping forceps</b>, 3x4 teeth, smooth</p>	<p>250 mm tk 775-5078-25 C 330 mm tk 775-5078 C 450 mm tk 775-5078-45 C</p>	<p>tk 775-5078-25 CS tk 775-5078 CS tk 775-5078-45 CS</p>

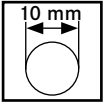

Fasszangen, zerlegbar  
*Grasping forceps, detachable*

Pincès à saisir, démontables  
*Pinzas de agarre, desmontables*  
Pinze da presa, smontabili









ohne Sperre  
*without ratchet*  
sans crémaillère  
*sin cremallera*  
senza cremagliera

mit Sperre  
*with ratchet*  
avec crémaillère  
*con cremallera*  
con cremagliera

Einsatz allein  
*Insert only*  
Insert seul  
*Inserto solo*  
Inserto, solo

**TEKNOLINE**

		Ø 10.0 mm	Ø 10.0 mm	Ø 10.0 mm			
 1:2	<b>Fasszange, atraumatisch, spitz</b> <i>Grasping forceps pointed, atraumatic</i> Pince à saisir, atraumatique, pointu <i>Pinza de agarre, atraumatica, aguda</i> Pinza da prega atraumatica, acuta	250 mm 330 mm 450 mm	<b>tk 775-5064-25 C</b> <b>tk 775-5064 C</b> <b>tk 775-5064-45 C</b>	<b>tk 775-5064-25 CS</b> <b>tk 775-5064 CS</b> <b>tk 775-5064-45 CS</b>	<b>tk 775-5064-25</b> <b>tk 775-5064</b> <b>tk 775-5064-45</b>		
	 1:2	<b>MARYLAND Fasszange, grob gerieft, gebogen</b> <i>MARYLAND coarse-serrated, curved</i> MARYLAND, strié fort, courbe <i>MARYLAND, estriada fuerte, curva</i> MARYLAND, zigrinatura larga, curva	250 mm 330 mm 450 mm	<b>tk 775-5069-25 C</b> <b>tk 775-5069 C</b> <b>tk 775-5069-45 C</b>	<b>tk 775-5069-25 CS</b> <b>tk 775-5069 CS</b> <b>tk 775-5069-45 CS</b>	<b>tk 775-5069-25</b> <b>tk 775-5069</b> <b>tk 775-5069-45</b>	
		 1:2	<b>MARYLAND Fasszange, fein gerieft, gebogen</b> <i>MARYLAND grasping forceps, fine serrated</i> MARYLAND, strié fin <i>MARYLAND, estriada fina</i> MARYLAND, pinza da presa, zigrinatura fina	250 mm 330 mm 450 mm	<b>tk 775-5021-25 C</b> <b>tk 775-5021 C</b> <b>tk 775-5021-45 C</b>	<b>tk 775-5021-25 CS</b> <b>tk 775-5021 CS</b> <b>tk 775-5021-45 CS</b>	<b>tk 775-5021-25</b> <b>tk 775-5021</b> <b>tk 775-5021-45</b>
			 1:2	<b>MARYLAND, kreuzgerieft</b> <i>MARYLAND, cross serrated</i> MARYLAND, strié en cruciforme <i>MARYLAND, estriada en cruciforma</i> MARYLAND, zigrinatura a croce	250 mm 330 mm 450 mm	<b>tk 775-5027-25 C</b> <b>tk 775-5027 C</b> <b>tk 775-5027-45 C</b>	<b>tk 775-5027-25 CS</b> <b>tk 775-5027 CS</b> <b>tk 775-5027-45 CS</b>
 1:2				<b>MARYLAND, DEBAKEY, gebogen</b> <i>MARYLAND, DEBAKEY, curved</i> MARYLAND, DEBAKEY, courbe <i>MARYLAND, DEBAKEY, curva</i> MARYLAND, DEBAKEY, curva	250 mm 330 mm 450 mm	<b>tk 775-5088-25 C</b> <b>tk 775-5088 C</b> <b>tk 775-5088-45 C</b>	<b>tk 775-5088-25 CS</b> <b>tk 775-5088 CS</b> <b>tk 775-5088-45 CS</b>
	 1:2			<b>MIXTER Fasszange, 45° gewinkelt</b> <i>MIXTER grasping forceps, 45° angled</i> MIXTER, 45° angulé <i>MIXTER, 45° angulada</i> MIXTER, pinza da presa angolata a 45°	250 mm 330 mm 450 mm	<b>tk 775-5028-25 C</b> <b>tk 775-5028 C</b> <b>tk 775-5028-45 C</b>	<b>tk 775-5028-25 CS</b> <b>tk 775-5028 CS</b> <b>tk 775-5028-45 CS</b>
		 1:2		<b>MIXTER Fasszange, 45° gebogen</b> <i>MIXTER grasping forceps, 45° curved</i> MIXTER, 45° courbé <i>MIXTER, 45° curvada</i> MIXTER, pinza da presa curva a 45°	250 mm 330 mm 450 mm	<b>tk 775-5022-25 C</b> <b>tk 775-5022 C</b> <b>tk 775-5022-45 C</b>	<b>tk 775-5022-25 CS</b> <b>tk 775-5022 CS</b> <b>tk 775-5022-45 CS</b>

Fasszangen, zerlegbar  
Grasping forceps, detachable

Pinces à saisir, démontables  
Pinzas de agarre, desmontables  
Pinze da presa, smontabili

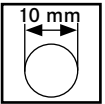







ohne Sperre  
*without ratchet*  
sans crémaillère  
*sin cremallera*  
senza cremagliera

mit Sperre  
*with ratchet*  
avec crémaillère  
*con cremallera*  
con cremagliera

Einsatz allein  
*Insert only*  
Insert seul  
*Inserto solo*  
Inserto, solo

**TEKNO**LINE

		Ø 10.0 mm	Ø 10.0 mm	Ø 10.0 mm
 <p>1:2 MIXTER Faszange, 90° gewinkelt <i>MIXTER grasping forceps, 90° angled</i> MIXTER, 90° angulé <i>MIXTER, 90° angulada</i> MIXTER, pinza da presa angolata a 90°</p>	250 mm	tk 775-5023-25 C	tk 775-5023-25 CS	tk 775-5023-25
	330 mm	tk 775-5023 C	tk 775-5023 CS	tk 775-5023
	450 mm	tk 775-5023-45 C	tk 775-5023-45 CS	tk 775-5023-45
 <p>1:2 COLLIN Faszange <i>COLLIN grasping forceps</i> COLLIN pince à saisir <i>COLLIN pinza de agarre</i> COLLIN pinza da presa</p>	250 mm	tk 775-5046-25 C	tk 775-5046-25 CS	tk 775-5046-25
	330 mm	tk 775-5046 C	tk 775-5046 CS	tk 775-5046
	450 mm	tk 775-5046-45 C	tk 775-5046-45 CS	tk 775-5046-45
 <p>1:2 TC-COLLIN Faszange, kreuzgerieft <i>TC-COLLIN grasping forceps, cross serrated</i> TC-COLLIN pince à saisir, strié <i>TC-COLLIN pinza de agarre, estriada</i> TC-COLLIN pinza da presa zigrinata a croce</p>	250 mm	tk 775-5034-25 C	tk 775-5034-25 CS	tk 775-5034-25
	330 mm	tk 775-5034 C	tk 775-5034 CS	tk 775-5034
	450 mm	tk 775-5034-45 C	tk 775-5034-45 CS	tk 775-5034-45
 <p>1:2 PENNINGTON Faszange <i>PENNINGTON grasping forceps</i> PENNINGTON pince à saisir <i>PENNINGTON pinza de agarre</i> PENNINGTON pinza da presa</p>	250 mm	tk 775-5024-25 C	tk 775-5024-25 CS	tk 775-5024-25
	330 mm	tk 775-5024 C	tk 775-5024 CS	tk 775-5024
	450 mm	tk 775-5024-45 C	tk 775-5024-45 CS	tk 775-5024-45
 <p>1:2 BABCOCK Faszange <i>BABCOCK-forceps</i> BABCOCK pince à saisir <i>BABCOCK pinza de agarre</i> BABCOCK pinza da presa</p>	250 mm	tk 775-5044-25 C	tk 775-5044-25 CS	tk 775-5044-25
	330 mm	tk 775-5044 C	tk 775-5044 CS	tk 775-5044
	450 mm	tk 775-5044-45 C	tk 775-5044-45 CS	tk 775-5044-45
 <p>1:2 ALLIS Faszange <i>ALLIS grasping forceps</i> ALLIS pince à saisir <i>ALLIS pinza de agarre</i> ALLIS pinza da presa</p>	250 mm	tk 775-5029-25 C	tk 775-5029-25 CS	tk 775-5029-25
	330 mm	tk 775-5029 C	tk 775-5029 CS	tk 775-5029
	450 mm	tk 775-5029-45 C	tk 775-5029-45 CS	tk 775-5029-45

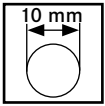

Fasszangen, zerlegbar  
Grasping forceps, detachable

Pincès à saisir, démontables  
Pinzas de agarre, desmontables  
Pinze da presa, smontabili







ohne Sperre  
*without ratchet*  
sans crémaillère  
*sin cremallera*  
senza cremagliera

mit Sperre  
*with ratchet*  
avec crémaillère  
*con cremallera*  
con cremagliera

Einsatz allein  
*Insert only*  
Insert seul  
*Inserto solo*  
Inserto, solo

**TEKNOLINE**

		Ø 10.0 mm	Ø 10.0 mm	Ø 10.0 mm			
 <p>1:2</p>	<b>DEBAKEY Fasszange, atraumatisch</b> <i>DEBAKEY grasping forceps, atraumatic</i> DEBAKEY, atraumatique <i>DEBAKEY, atraumatica</i> DEBAKEY pinza da presa atraumatica	250 mm 330 mm 450 mm	<b>tk 775-5026-25 C</b> <b>tk 775-5026 C</b> <b>tk 775-5026-45 C</b>	<b>tk 775-5026-25 CS</b> <b>tk 775-5026 CS</b> <b>tk 775-5026-45 CS</b>	<b>tk 775-5026-25</b> <b>tk 775-5026</b> <b>tk 775-5026-45</b>		
	 <p>1:2</p>	<b>ANVIL Fasszange</b> <i>ANVIL grasping forceps</i> ANVIL pince à saisir <i>ANVIL pinza de agarre</i> ANVIL pinza da presa	250 mm 330 mm 450 mm	<b>tk 775-5038-25 C</b> <b>tk 775-5038 C</b> <b>tk 775-5038-45 C</b>	<b>tk 775-5038-25 CS</b> <b>tk 775-5038 CS</b> <b>tk 775-5038-45 CS</b>	<b>tk 775-5038-25</b> <b>tk 775-5038</b> <b>tk 775-5038-45</b>	
		 <p>1:2</p>	<b>ALLIS Fasszange</b> <i>ALLIS grasping forceps</i> ALLIS pince à saisir <i>ALLIS pinza de agarre</i> ALLIS pinza da presa	250 mm 330 mm 450 mm	<b>tk 775-5041-25 C</b> <b>tk 775-5041 C</b> <b>tk 775-5041-45 C</b>	<b>tk 775-5041-25 CS</b> <b>tk 775-5041 CS</b> <b>tk 775-5041-45 CS</b>	<b>tk 775-5041-25</b> <b>tk 775-5041</b> <b>tk 775-5041-45</b>
			 <p>1:2</p>	<b>TENACULUM Hakenzange, scharf</b> <i>TENACULUM forceps, sharp</i> TENACULUM, pince à crochet, pointue <i>TENACULUM, pinza de gancho, aguda</i> TENACULUM pinza ad uncino, acuta	250 mm 330 mm 450 mm	<b>tk 775-5253-25 C</b> <b>tk 775-5253 C</b> <b>tk 775-5253-45 C</b>	<b>tk 775-5253-25 CS</b> <b>tk 775-5253 CS</b> <b>tk 775-5253-45 CS</b>

**Bipolare Instrumente, zerlegbar**  
*Bipolar instruments, detachable*

Instrumentes bipolaires, démontables  
*Instrumentos bipolares, desmontables*  
Strumenti bipolari, smontabili

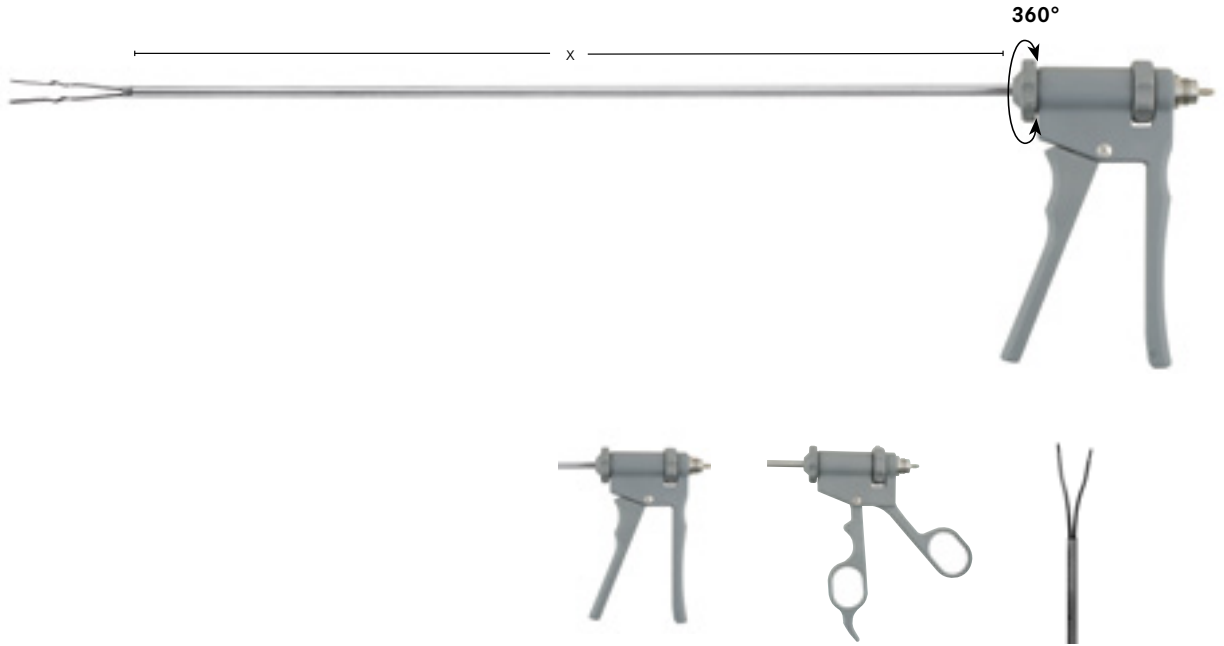
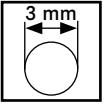

Ø 3.0 mm	x = 340 mm	x = 340 mm	
<b>Gewellter Steg</b> <i>Rippled bar</i> Mors avec insert ondulé <i>Boca con inserto ondulado</i> Morso finestrato ondulado	<b>tk 707-012 ZDR</b>	<b>tk 707-112 ZDR</b>	<b>tk 707-012 E</b>
<b>Pinzettenspitze</b> <i>Fluted tip</i> Mors fins <i>Boca fina</i> Morso fine	<b>tk 707-013 ZDR</b>	<b>tk 707-113 ZDR</b>	<b>tk 707-013 E</b>
<b>Bipolare Instrumente</b> <i>Bipolar instruments</i> Instrumentes bipolaires <i>Instrumentos bipolares</i> Strumenti bipolari	Zange, komplett <i>Forceps, complete</i> Pince, complète <i>Pinza, completa</i> Strumento, completo	Zange, komplett <i>Forceps, complete</i> Pince, complète <i>Pinza, completa</i> Strumento, completo	Elektrode, allein <i>Electrode, only</i> Electrode, seule <i>Electrodo, solo</i> Elettrodo, solo



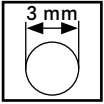

Bipolare Instrumente, zerlegbar  
*Bipolar instruments, detachable*

Instruments bipolaires, démontables  
*Instrumentos bipolares, desmontables*  
Strumenti bipolari, smontabili

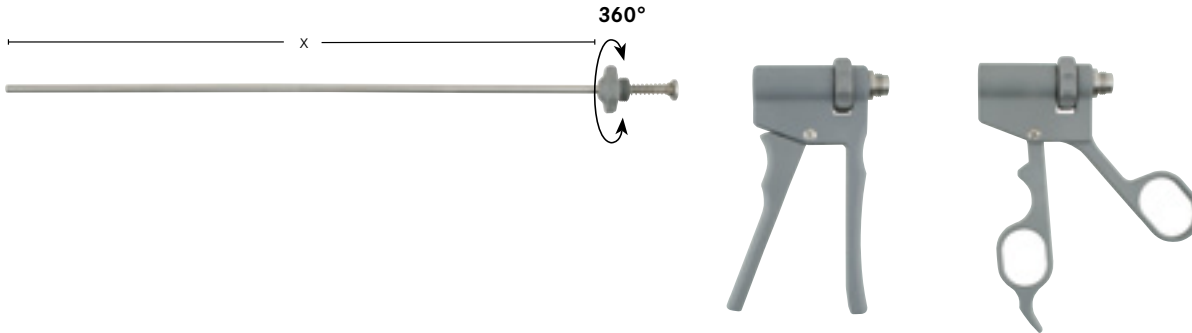

Ø 3.0 mm / x = 340 mm	tk 707-040	tk 707-041	tk 707-042
Ersatzteile <i>Spare parts</i> Pièces de réchange <i>Piezas de recambio</i> Pezzi di ricambio	Doppelschaft <i>Double shaft</i> Tige double <i>Cánula doble</i> Camicia doppia	Standardgriff <i>Standard handle</i> Poignée standard <i>Mango estándar</i> Manico Standard	Ringgriff <i>Ring handle</i> Poignée à bagues <i>Mango de anillos</i> Manico ad anelli

autoklavierbar / autoclavable  
134°C / 273°F - 18 min.

	Erbe ICC/ACC, Wisap, Storz	3m	tk 707-340	
	Martin, Berchtold	3m	tk 707-341	
	TEKNO, Valleylab USA	3m	tk 707-342	
	TEKNO, Valleylab Europe	3m	tk 707-343	

Geräteseite  
*Unit side*  
Coté appareil  
*Lado equipo*  
Lato elettrobisturi

Instrumentenseite  
*Instrument side*  
Coté instrument  
*Lado instrumento*  
Lato strumento



**Bipolare Instrumente, zerlegbar**  
*Bipolar instruments, detachable*

Instrumentes bipolaires, démontables  
*Instrumentos bipolares, desmontables*  
Strumenti bipolari, smontabili

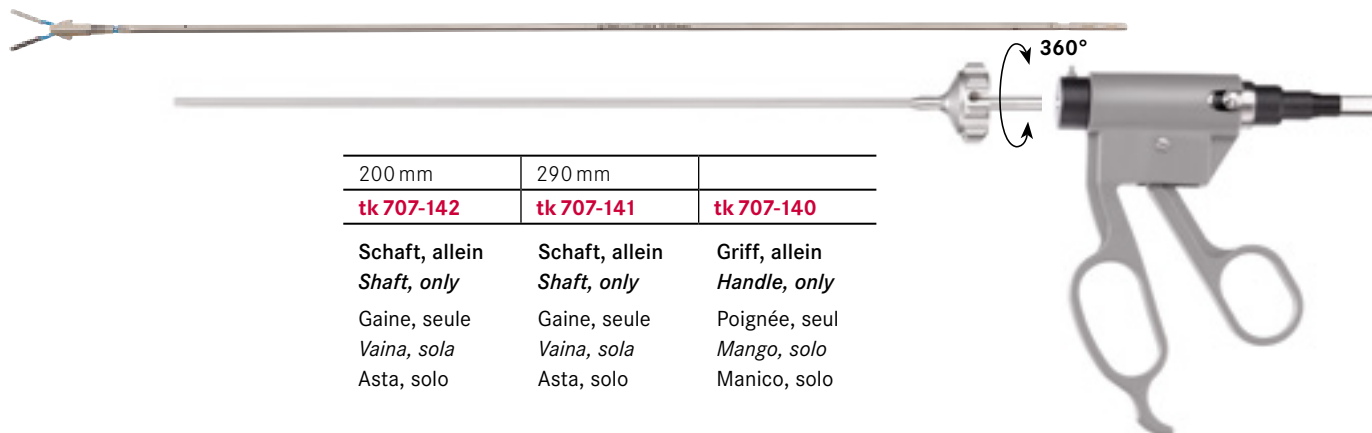
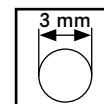

200 mm	290 mm	
<b>tk 707-142</b>	<b>tk 707-141</b>	<b>tk 707-140</b>
Schaft, allein <i>Shaft, only</i>	Schaft, allein <i>Shaft, only</i>	Griff, allein <i>Handle, only</i>
Gaine, seule <i>Vaina, sola</i>	Gaine, seule <i>Vaina, sola</i>	Poignée, seul <i>Mango, solo</i>
Asta, solo	Asta, solo	Manico, solo

Ø 3.0 mm			
<b>MARYLAND Fasszange</b> <i>MARYLAND grasping forceps</i>			
MARYLAND pince <i>MARYLAND pinza</i> MARYLAND pinza	200 mm 290 mm	<b>tk 707-146</b> <b>tk 707-144</b>	<b>tk 707-046</b> <b>tk 707-044</b>
<b>Fasszange, gefenstert</b> <i>Grasping forceps, fenestrated</i>			
Pince à saisir, fenêtrée <i>Pinza de agarre, fenestrada</i> Pinza da presa, fenestrata	200 mm 290 mm	<b>tk 707-147</b> <b>tk 707-145</b>	<b>tk 707-047</b> <b>tk 707-045</b>



Zange, komplett  
*Forceps, complete*  
Pince, complète  
*Pinza, completa*  
Strumento, completo

Einsatz, allein  
*Insert, only*  
Insert, seul  
*Inserto, solo*  
Inserto, solo

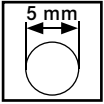

**Bipolare Instrumente, zerlegbar**  
*Bipolar instruments, detachable*

Instrumentes bipolaires, démontables  
*Instrumentos bipolares, desmontables*  
Strumenti bipolari, smontabili

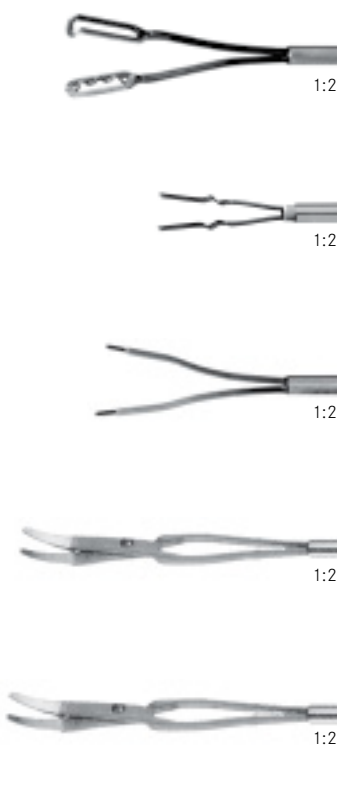



Ø 5.0 mm	340 mm	340 mm	
<b>Gewellter Steg</b> <i>Rippled bar</i> Mors avec insert ondulé <i>Boca con inserto ondulado</i> Morso fenestrato ondulato	tk 707-000 ZDR	tk 707-100 ZDR	tk 707-000 E
<b>Zangenartiges Maul</b> <i>Tong-typ jaw</i> Pince <i>Pinza</i> Pinza da presa	tk 707-001 ZDR	tk 707-101 ZDR	tk 707-001 E
<b>Pinzettenspitze</b> <i>Fluted tip</i> Mors fins <i>Boca fina</i> Morso fine	tk 707-003 ZDR	tk 707-103 ZDR	tk 707-003 E
<b>Schere, gebogen</b> <i>Scissors, curved</i> Ciseaux courbes <i>Tijera curva</i> forbice, curva	tk 707-005 ZDR	tk 707-105 ZDR	tk 707-005 E
<b>Schere mit HM, gebogen</b> <i>Scissors with TC-blades, curved</i> Ciseaux TC courbes <i>Tijera TC curva</i> Forbice con lame TC, curva	tk 707-006 ZDR	tk 707-106 ZDR	tk 707-006 E

mit Adapter für Flachstecker <i>with adaptor for flat plug</i>	Zange, komplett <i>Forceps, complete</i>	Zange, komplett <i>Forceps complete</i>	Elektrode, allein <i>Electrode, only</i>
avec adaptateur avec raccord plat <i>con adaptator con conexión plana</i>	Pince, completè <i>Pinza, completa</i>	Pince, completè <i>Pinza, completa</i>	Electrode, seule <i>Electrodo, solo</i>
con adattore per spina piatta	Strumento, completo	Strumento, completo	Elettrodo, solo

Bipolare Instrumente, zerlegbar  
Bipolar instruments, detachable

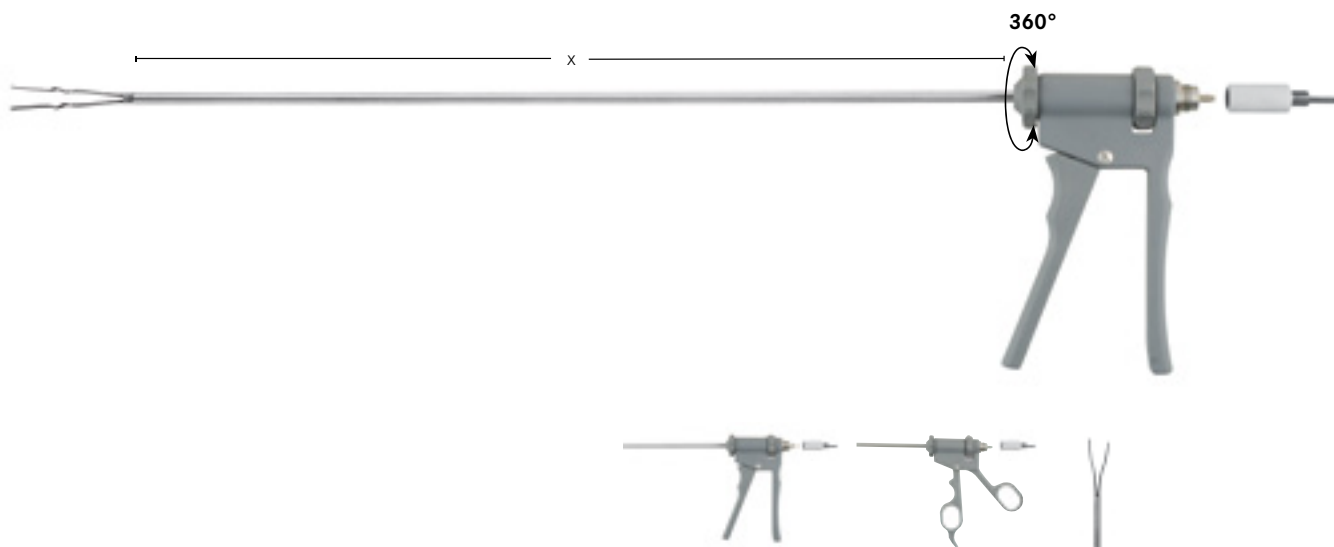
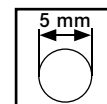
Instruments bipolaires, démontables  
Instrumentos bipolares, desmontables  
Strumenti bipolari, smontabili



	Ø 5.0 mm	340 mm	340 mm	
 1:2	KLEPPINGER, gerieft KLEPPINGER, serrated			
	KLEPPINGER, strié KLEPPINGER, estriada KLEPPINGER, zigrinato	tk 707-008 ZDR	tk 707-108 ZDR	tk 707-008 E
	MARYLAND Dissektor, gebogen MARYLAND dissector, curved			
	MARYLAND dissecteur, courbe MARYLAND dissector, curvo MARYLAND dissetto, curvo	tk 707-009 ZDR	tk 707-109 ZDR	tk 707-009 E

mit Adapter für Flachstecker with adaptor for flat plug	Zange, komplett Forceps, complete	Zange, komplett Forceps, complete	Elektrode, allein Electrode, only
avec adaptateur avec raccord plat	Pince, completè	Pince, completè	Electrode, seule
con adaptor con conexión plana	Pinza, completa	Pinza, completa	Electrodo, solo
con adattore per spina piatta	Strumento, completo	Strumento, completo	Elettrodo, solo

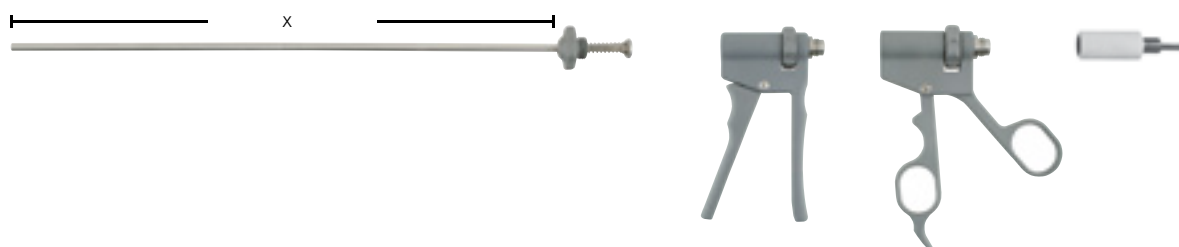

Ø 5 mm - x = 340 mm	tk 707-013	tk 707-014	tk 707-015	tk 707-016	tk 707-010
---------------------	------------	------------	------------	------------	------------

Ersatzteile Spare parts	Innenrohr Inner tube	Außenrohr Outer tube	Standardgriff Standard handle	Ringgriff Ring handle	Adapter mit Flachstecker Adaptor with flat plug
Pièces de réchange Piezas de recambio Pezzi di ricambio	Gaine interne Vaina interna Tubo interno	Gaine externe Vaina externa Tubo esterno	Poignée standard Mango estándar Manico Standard	Poignée à bagues Mango de anillos Manico ad anelli	Adaptateur avec raccord plat Adaptator con conexión plana Adattatore con spina piatta

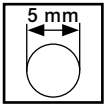



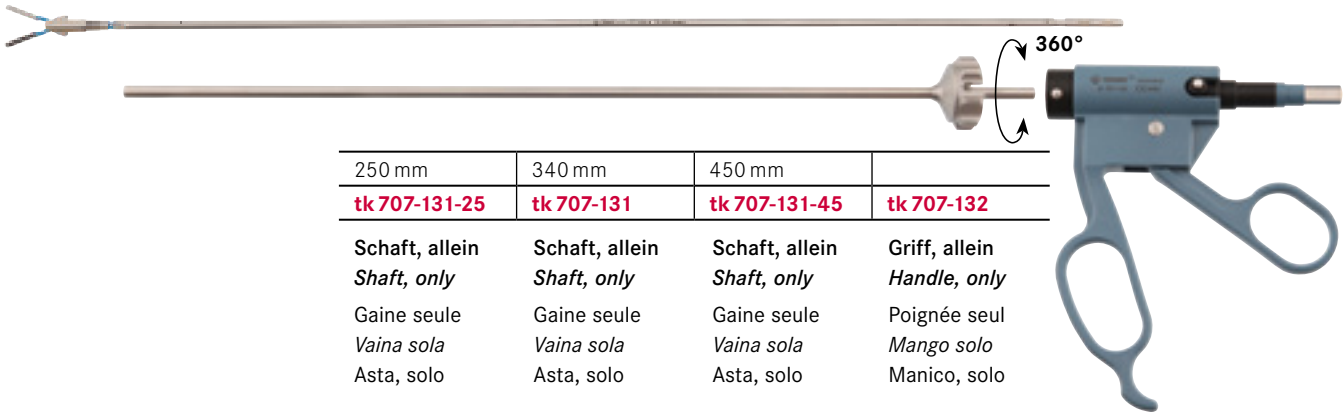

**Bipolare Koagulationszange EVO II**  
*Bipolar coagulation forceps EVO II*

**Pince bipolaire EVO II**  
*Pinza bipolar EVO II*  
*Pinza bipolari, EVO II*

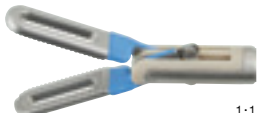
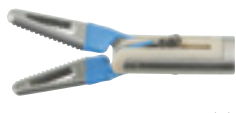
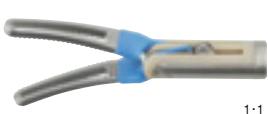

250 mm	340 mm	450 mm	
<b>tk 707-131-25</b>	<b>tk 707-131</b>	<b>tk 707-131-45</b>	<b>tk 707-132</b>
Schaft, allein <i>Shaft, only</i>	Schaft, allein <i>Shaft, only</i>	Schaft, allein <i>Shaft, only</i>	Griff, allein <i>Handle, only</i>
Gaine seule <i>Vaina sola</i>	Gaine seule <i>Vaina sola</i>	Gaine seule <i>Vaina sola</i>	Poignée seul <i>Mango solo</i>
Asta, solo	Asta, solo	Asta, solo	Manico, solo

Ø 5.0 mm			
 1:1	<b>MARYLAND Fassungzange</b> <i>MARYLAND grasping forceps</i>	250 mm 340 mm 450 mm	<b>tk 707-120-25</b> <b>tk 707-120</b> <b>tk 707-120-45</b>
	MARYLAND pince <i>MARYLAND pinza</i> MARYLAND pinza		<b>tk 707-020-25</b> <b>tk 707-020</b> <b>tk 707-020-45</b>
 1:1	<b>METZENBAUM Schere, gebogen</b> <i>METZENBAUM scissors, curved</i>	250 mm 340 mm 450 mm	<b>tk 707-121-25</b> <b>tk 707-121</b> <b>tk 707-121-45</b>
	METZENBAUM ciseaux, courbes <i>METZENBAUM tijera, curva</i> METZENBAUM forbice curva		<b>tk 707-021-25</b> <b>tk 707-021</b> <b>tk 707-021-45</b>
 1:1	<b>Fassungzange, gefenstert</b> <i>Grasping forceps, fenestrated</i>	250 mm 340 mm 450 mm	- <b>tk 707-122</b> <b>tk 707-122-45</b>
	Pince à saisir, fenêtrée <i>Pinza de agarre, fenestrada</i> Pinza da presa, fenestrata		- <b>tk 707-022</b> <b>tk 707-022-45</b>
 1:1	<b>Fassungzange, gefenstert, spitz</b> <i>Grasping forceps, fenestrated, pointed</i>	250 mm 340 mm 450 mm	- <b>tk 707-123</b> <b>tk 707-123-45</b>
	Pince à saisir, fenêtrée, pointue <i>Pinza de agarre, fenestrada, aguda</i> Pinza da presa, fenestrata, acuta		- <b>tk 707-023</b> <b>tk 707-023-45</b>
 1:1	<b>Fassungzange, gefenstert, gebogen</b> <i>Grasping forceps, fenestrated, curved</i>	250 mm 340 mm 450 mm	<b>tk 707-124-25</b> <b>tk 707-124</b> <b>tk 707-124-45</b>
	Pince à saisir, fenêtrée, courbe <i>Pinza de agarre, fenestrada, curva</i> Pinza da presa, fenestrata, curva		<b>tk 707-024-25</b> <b>tk 707-024</b> <b>tk 707-024-45</b>
 1:1	<b>Pinzettenspitze</b> <i>Fluted tip</i>	250 mm 340 mm 450 mm	<b>tk 707-125-25</b> <b>tk 707-125</b> <b>tk 707-125-45</b>
	Mors fins <i>Boca fina</i> Morso fine		<b>tk 707-025-25</b> <b>tk 707-025</b> <b>tk 707-025-45</b>
 1:1	<b>Hakenzange</b> <i>Claw forceps</i>	250 mm 340 mm 450 mm	- <b>tk 707-126</b> <b>tk 707-126-45</b>
	Pince á griffes <i>Pinza de gaucho</i> Pinza a gancio		- <b>tk 707-026</b> <b>tk 707-026-45</b>



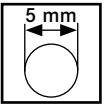

Zange, komplett <i>Forceps, complete</i>	Einsatz, allein <i>Insert, only</i>
Pince, complète <i>Pinza, completa</i>	Insert, seul <i>Inserto, solo</i>
Strumento, completo	Inserto, solo

**Bipolare Koagulationszange EVO III**  
*Bipolar coagulation forceps EVO III*

**Pince bipolaire EVO III**  
*Pinza bipolar EVO III*  
*Pinza bipolari, EVO III*



340 mm	450 mm	
<b>tk 707-133</b>	<b>tk 707-133-45</b>	<b>tk 707-134</b>
Schaft, allein <i>Shaft, only</i>	Schaft, allein <i>Shaft, only</i>	Griff, allein <i>Handle, only</i>
Gaine seule <i>Vaina sola</i>	Gaine seule <i>Vaina sola</i>	Poignée seul <i>Mango solo</i>
Asta, solo	Asta, solo	Manico, solo

	Ø 5.0 mm				
 1:1	<b>MARYLAND Fasszange</b> <i>MARYLAND grasping forceps</i> MARYLAND pince <i>MARYLAND pinza</i> MARYLAND pinza	340 mm 450 mm	<b>tk 707-170</b> <b>tk 707-170-45</b>	<b>tk 707-070</b> <b>tk 707-070-45</b>	
	 1:1	<b>METZENBAUM Schere, gebogen</b> <i>METZENBAUM scissors, curved</i> METZENBAUM ciseaux, courbes <i>METZENBAUM tijera, curva</i> METZENBAUM forbice curva	340 mm 450 mm	<b>tk 707-171</b> <b>tk 707-171-45</b>	<b>tk 707-071</b> <b>tk 707-071-45</b>
		 1:1	<b>Fasszange, gefenestert</b> <i>Grasping forceps, fenestrated</i> Pince à saisir, fenêtrée <i>Pinza de agarre, fenestrada</i> Pinza da presa, fenestrata	340 mm 450 mm	<b>tk 707-173</b> <b>tk 707-173-45</b>
	 1:1		<b>Fasszange, gefenestert, gebogen</b> <i>Grasping forceps, fenestrated, curved</i> Pince à saisir, fenêtrée, courbe <i>Pinza de agarre, fenestrada, curva</i> Pinza da presa, fenestrata, curva	340 mm 450 mm	<b>tk 707-172</b> -

Zange, komplett <i>Forceps, complete</i>	Einsatz, allein <i>Insert, only</i>
Pince, complète <i>Pinza, completa</i>	Insert, seul <i>Inserto, solo</i>
Strumento, completo	Inserto, solo

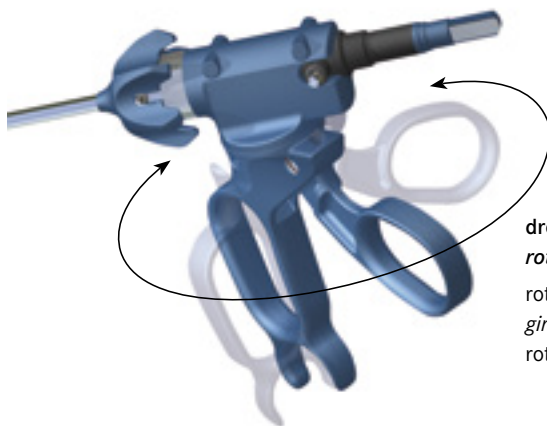

drehbar  
*rotatable*  
rotatives  
*giratorias*  
rotanti

Knotenschieber, Fasszangen  
Knotguides, Grasping forceps

Pousse-nœuds, pinces à saisir  
Guía de ligaduras, pinzas de agarre  
Spingi-nodi, pinze da presa

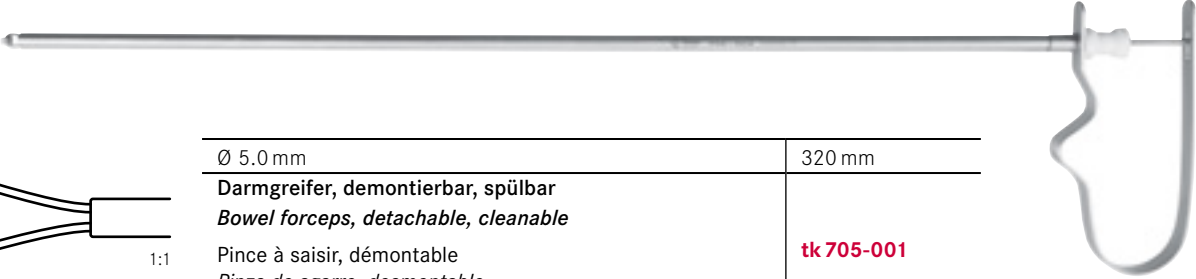

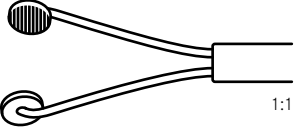
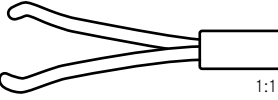
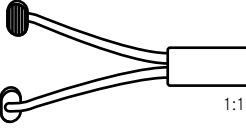
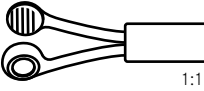
	Ø 5.0 mm	320 mm
 1:1	Darmgreifer, demontierbar, spülbar <i>Bowel forceps, detachable, cleanable</i> Pince à saisir, démontable <i>Pinza de agarre, desmontable</i> Pinza intestinale, smontabile	<b>tk 705-001</b>
 1:1	Atraumatische Fasszange, demontierbar, spülbar <i>Atraumatic grasping forceps, detachable, cleanable</i> Pince à saisir, atraumatique, démontable <i>Pinza de agarre, atraumatica, desmontable</i> Pinza da presa atraumatica, smontabile	<b>tk 705-002</b>
 1:1	Eileiter-Fasszange, T-förmig, demontierbar, spülbar <i>Fimbrial holding forceps, T-pattern, detachable, cleanable</i> Pince à saisir les trompes, en forme "T", démontable <i>Pinza para tener las trompas, en forma de "T", desmontable</i> Pinza presa-tube, forma "T", smontabile	<b>tk 705-004</b>
 1:1	Eileiter-Fasszange, ring-förmig, demontierbar, spülbar <i>Fimbrial holding forceps, ring-pattern, detachable, cleanable</i> Pince à saisir les trompes, ronde, démontable <i>Pinza para tener las trompas, redonda, desmontable</i> Pinza presa tube, forma d'anello, smontabile	<b>tk 705-005</b>

	Ø 5 mm
330 mm	<b>tk 704-106</b>
450 mm	<b>tk 704-108</b>

Knotenschieber mit Öse  
*Knotguide with eyelet*  
Pousse-nœuds avec œillet  
*Guía de ligaduras con ojete*  
Spingi-nodo con cruna

	Ø 5 mm
330 mm	<b>tk 704-107</b>

Knotenschieber mit Längsschlitz  
*Knotguide with slit*  
Pousse-nœuds avec fissure  
*Guía de ligaduras con abertura*  
Spingi-nodo con fessura

Nahtinstrumente  
Closure instruments

Instruments de suture  
Instrumentos de sutura  
Strumenti per sutura

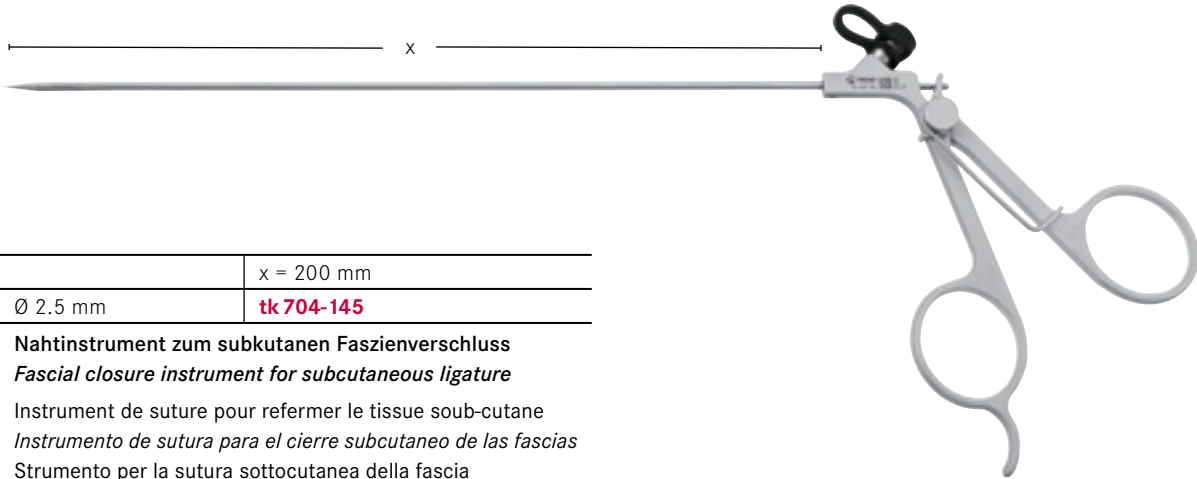

	x = 200 mm
Ø 2.5 mm	<b>tk 704-145</b>

Nahtinstrument zum subkutanen Faszienschluss  
*Fascial closure instrument for subcutaneous ligature*

Instrument de suture pour refermer le tissu sous-cutané  
*Instrumento de sutura para el cierre subcutáneo de las fascias*  
Strumento per la sutura sottocutanea della fascia



FSAD - FASCIA SUTURE ASSISTING DEVICE	
	x = 140 mm
Ø 2.3 mm	<b>tk 704-140</b>

Nahtinstrument  
*Fascial closure instrument*





Instrument de suture  
*Instrumento de sutura*  
Strumento per della fascia sutura



Leichtgewicht Nadelhalter, nicht zerlegbar  
*Lightweight needle holder, not detachable*

Porte-aiguilles légères, non-démontables  
*Porta-agujas ligeros, no desmontables*  
 Port'aghi leggero, non smontabile



		Ø 3.0 mm	Ø 3.0 mm
	<b>Nadelhalter, gerade</b> <i>Needle holder, straight</i> Porte-aiguilles, droit <i>Porta-agujas, recta</i> Port'aghi, retto	250 mm 330 mm	<b>tk 708-560</b> <b>tk 708-562</b> <b>tk 708-561</b> <b>tk 708-563</b>
	<b>Nadelhalter, links gebogen</b> <i>Needle holder, left curved</i> Porte-aiguilles, courbe à gauche <i>Porta-agujas, curva a la izquierda</i> Port'aghi, curvo a sinistra	250 mm 330 mm	<b>tk 708-564</b> <b>tk 708-566</b> <b>tk 708-565</b> <b>tk 708-567</b>
	<b>Nadelhalter, rechts gebogen</b> <i>Needle holder, right curved</i> Porte-aiguilles, courbe à droite <i>Porta-agujas, curva a la derecha</i> Port'aghi, curvo a destra	250 mm 330 mm	<b>tk 708-568</b> <b>tk 708-570</b> <b>tk 708-569</b> <b>tk 708-571</b>
			Ø 5.0 mm
	<b>Nadelhalter, gerade</b> <i>Needle holder, straight</i> Porte-aiguilles, droit <i>Porta-agujas, recta</i> Port'aghi, retto	330 mm 450 mm	<b>tk 708-540</b> <b>tk 708-542</b> <b>tk 708-541</b> <b>tk 708-543</b>
	<b>Nadelhalter, links gebogen</b> <i>Needle holder, left curved</i> Porte-aiguilles, courbe à gauche <i>Porta-agujas, curva a la izquierda</i> Port'aghi, curvo a sinistra	330 mm 450 mm	<b>tk 708-544</b> <b>tk 708-546</b> <b>tk 708-545</b> <b>tk 708-547</b>
	<b>Nadelhalter, rechts gebogen</b> <i>Needle holder, right curved</i> Porte-aiguilles, courbe à droite <i>Porta-agujas, curva a la derecha</i> Port'aghi, curvo a destra	330 mm 450 mm	<b>tk 708-548</b> <b>tk 708-550</b> <b>tk 708-549</b> <b>tk 708-551</b>
	<b>Nadelhalter Flamingo, gerade</b> <i>Needle holder Flamingo, straight</i> Porte-aiguilles Flamant, droit <i>Porta-agujas Flamenca, recta</i> Port'aghi Flamingo, retto	330 mm 450 mm	<b>tk 708-552</b> <b>tk 708-554</b> <b>tk 708-553</b> <b>tk 708-555</b>
	<b>Nadelhalter 1x2 Zähne, gerade</b> <i>Needle holder 1x2 teeth, straight</i> Porte-aiguilles 1x2 dents, droit <i>Porta-agujas 1x2 dientes, recta</i> Port'aghi, 1x2 denti, dritto	330 mm 450 mm	<b>tk 708-556</b> <b>tk 708-558</b> <b>tk 708-557</b> <b>tk 708-559</b>







Handgriff, gerade <i>Handle, straight</i>	Handgriff, gebogen <i>Handle, curved</i>
Manche, droit <i>Mango, recta</i>	Manche, courbe <i>Mango, curva</i>
Manico, dritta	Manico, curva



**Leichtgewicht Nadelhalter, zerlegbar**  
*Lightweight needle holder, detachable*

Porte-aiguilles légères, démontables  
*Porta-agujas ligeros, desmontables*  
 Port'aghi leggero, smontabile



		Ø 5.0 mm	Ø 5.0 mm	Ø 5.0 mm
 Nadelhalter, TC, gerade <i>Needle holder, TC, straight</i> Porte-aiguilles, TC, droit <i>Porta-agujas, TC, recta</i> Port'aghi, TC, retto	330 mm	tk 708-640	tk 708-641	tk 708-634
 Nadelhalter, TC, links gebogen <i>Needle holder, TC, left curved</i> Porte-aiguilles, TC, courbe à gauche <i>Porta-agujas, TC, curva a la izquierda</i> Port'aghi, TC, curvo a sinistra	330 mm	tk 708-644	tk 708-645	tk 708-635
 Nadelhalter, TC, rechts gebogen <i>Needle holder, TC, right curved</i> Porte-aiguilles, TC, courbe à droite <i>Porta-agujas, TC, curva a la derecha</i> Port'aghi, TC, curvo a destra	330 mm	tk 708-648	tk 708-649	tk 708-636
 Nadelhalter Flamingo, diamantiert, gerade <i>Needle holder Flamingo, diamond coated, straight</i> Porte-aiguilles Flamant, diamanté, droit <i>Porta-agujas Flamenco, diamantada, recta</i> Port'aghi Flamingo, diamantata, retto	330 mm	tk 708-652	tk 708-653	tk 708-637
 Nadelhalter 1x2 Zähne, TC, gerade <i>Needle holder 1x2 teeth, TC, straight</i> Porte-aiguilles 1x2 dents, TC, droit <i>Porta-agujas 1x2 dientes, TC, recta</i> Port'aghi, 1x2 denti, TC, retto	330 mm	tk 708-656	tk 708-657	tk 708-638
 Nadelhalter, gerade, gerieft <i>Needle holder, straight, serrated</i> Porte-aiguilles, droit, strié <i>Porta-agujas, boca recta, estriada</i> Port'aghi, morso retto, zigrinato	330 mm	tk 708-660	tk 708-661	tk 708-639

komplett <i>complete</i>	komplett <i>complete</i>	Einsatz allein <i>Insert, only</i>
complet <i>completo</i>	complet <i>completo</i>	Insert, seul <i>Inserto, solo</i>
completo	completo	Inserto, solo

tk 708-630	tk 708-631
Handgriff, gerade <i>Handle, straight</i> Manche, droit <i>Mango, recta</i> Impugnatura, retta	Handgriff, gebogen <i>Handle, curved</i> Manche, courbe <i>Mango, curva</i> Impugnatura, angolata

	Ø 5.0 mm
330 mm	tk 708-633
	Metallschaft <i>Metal shaft</i> Gaine métallique <i>Vaina de metal</i> Camicia di metallo

Nadelhalter mit Axial-Griff, mit LL  
*Needle holders with axial handle, with LL*

Porte-aiguilles avec manche axial, connecteur LL  
*Porta-agujas con mango axial, conexión LL*  
*Port'aghi con impugnatura assiale, con LL*



1:1

Ø 5.0 mm - 330 mm

**Maul kreuzgerieft mit Hartmetalleinsatz, gerade**  
*Jaw cross serrated with TC-inserts, straight*

Mors strié transversal, inserts TC, droit  
*Boca estriada transversal, insertos TC, recta*  
 Morso zigrinato a croce, inserto TC, retto

**tk 708-520**



1:1

**Maul kreuzgerieft mit Hartmetalleinsatz, links gebogen**  
*Jaw cross serrated with TC-inserts, left curved*

Mors strié transversal, inserts TC, courbe à gauche  
*Boca estriada transversal, insertos TC, curva a la izquierda*  
 Morso zigrinato a croce, inserto TC, curvo a sinistra

**tk 708-521**



1:1

**Maul kreuzgerieft mit Hartmetalleinsatz, rechts gebogen**  
*Jaw cross serrated with tungsten carbide inserts, right curved*







Mors strié transversal, inserts TC, courbe à droite  
*Boca estriada transversal, insertos TC, curva a la derecha*  
 Morso zigrinato a croce, inserto TC, curvo a destra

**tk 708-522**

Nadelhalter mit Axial-Griff, mit LL  
*Needle holders with axial handle, with LL*

Porte-aiguilles avec manche axial, connecteur LL  
*Porta-agujas con mango axial, conexión LL*  
 Port'aghi con impugnatura assiale, con LL



	Ø 5.0 mm - 320 mm	
	Maul kreuzgerieft, gerade <i>Jaw cross serrated, straight</i>	tk 708-100 LL
1:1	Mors strié transversal, droit <i>Boca estriada transversal, recta</i> Morso zigrinato a croce, retto	
	Maul kreuzgerieft, TEKNO-FLAM <i>Jaw cross serrated, TEKNO-FLAM</i>	tk 708-110 LL
1:1	Mors strié transversal, TEKNO-FLAM <i>Boca estriada transversal, TEKNO-FLAM</i> Morso zigrinato a croce, TEKNO-FLAM	
	Maul kreuzgerieft mit Hartmetalleinsatz, gerade <i>Jaw cross serrated with TC-inserts, straight</i>	tk 708-511 LL
1:1	Mors strié transversal, inserts TC, droit <i>Boca estriada transversal, insertos TC, recta</i> Morso zigrinato a croce, inserto TC, retto	
	Maul kreuzgerieft mit Hartmetalleinsatz, links gebogen <i>Jaw cross serrated with TC-inserts, left curved</i>	tk 708-512 LL
1:1	Mors strié transversal, inserts TC, courbe á gauche <i>Boca estriada transversal, insertos TC, curva a la izquierda</i> Morso zigrinato a croce, inserto TC, curvo a sinistra	
	Maul kreuzgerieft mit Hartmetalleinsatz, rechts gebogen <i>Jaw cross serrated with TC-inserts, right curved</i>	tk 708-513 LL
1:1	Mors strié transversal, inserts TC, courbe á droite <i>Boca estriada transversal, insertos TC, curva a la derecha</i> Morso zigrinato a croce, inserto TC, curvo a destra	
	Maul diamantiert, automatische Nadelaufrichtung <i>Jaw diamond coated, automatic needle positioning</i>	tk 708-530
1:1	Mors diamanté, positionnement automatique de l'aiguille <i>Boca diamantada, posicionar automatico de la aguja</i> Morso diamantato, posizionamento automatico dell'ago	

Instrumente, nicht zerlegbar, mit LL  
*Instruments, not detachable, with LL*

Instruments non-démontables, connecteur LL  
*Instrumentos no desmontables, conexión LL*  
 Strumenti non smontabile, con LL



1:1



1:1



1:1

		Ø 3.0 mm	Ø 5.0 mm
Nadelhalter, Maul kreuzgerieft <i>Needle holder, jaw cross serrated</i>	320 mm	tk 703-102 LL	-
Porte-aiguilles, mors strié transversal <i>Porta-agujas, boca estriada transversal</i>	330 mm	-	tk 703-100 LL
Port'aghi, morso zigrinato a croce <b>Maul kreuzgerieft mit Hartmetalleinlage</b> <i>Jaw cross serrated with TC-inserts</i>	330 mm	-	tk 703-510 LL
Mors strié transversal avec inserts TC <i>Boca estriada transversal con insertos TC</i> Morso zigrinato a croce con inserti TC <b>Maul kreuzgerieft mit Hartmetalleinlage, gebogen</b> <i>Jaw cross serrated with TC-inserts, curved</i>	320 mm	-	tk 703-512 LL
Mors strié transversal avec inserts TC, courbe <i>Boca estriada transversal con insertos TC, curva</i> Morso zigrinato a croce con inserti TC, curvo			

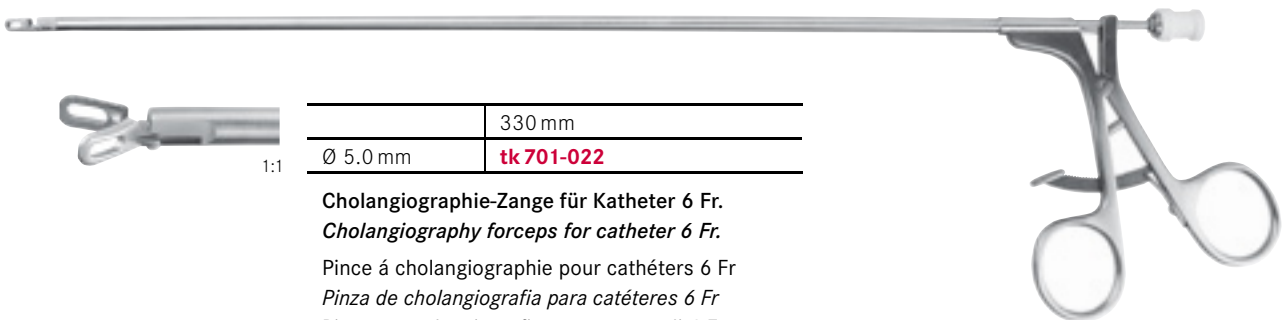

1:1

	330 mm
Ø 5.0 mm	tk 701-022

Cholangiographie-Zange für Katheter 6 Fr.  
*Cholangiography forceps for catheter 6 Fr.*

Pince à cholangiographie pour cathéters 6 Fr  
*Pinza de cholangiografia para catéteres 6 Fr*  
 Pinza per colangiografia per catetere di 6 Fr.

Clip Anlegezangen  
Clip application forceps

Pinces à poser des clips  
Pinzas para clips  
Pinze per applicatori di clip

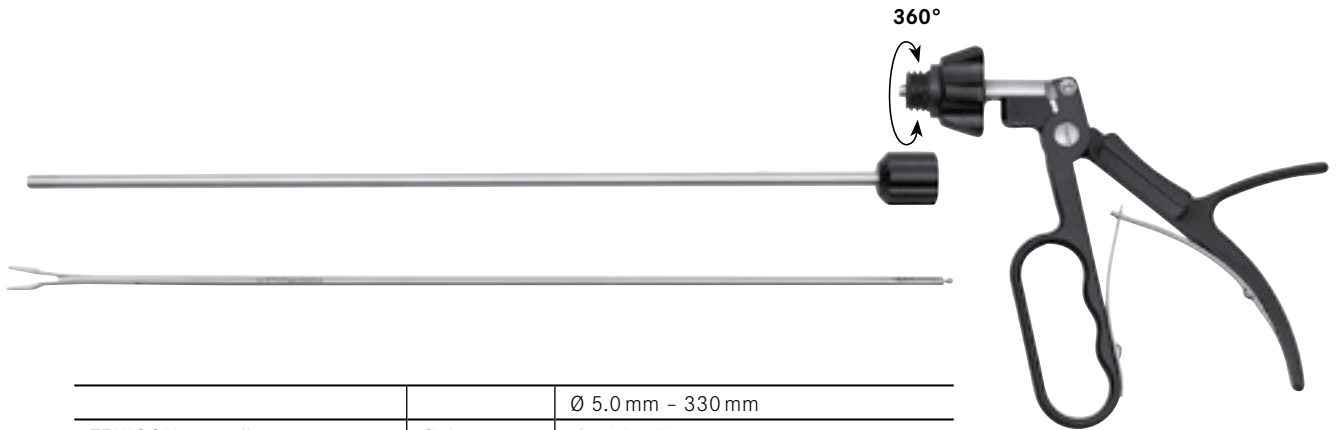

		Ø 5.0 mm - 330 mm
ETHICON - small	Ø 6.5 mm	<b>tk 708-680</b>

für Clips Typ  
for clips type  
pour clips, type  
para clips, tipo  
per clips tipo

für Trokare  
for trocars  
pour trocars  
para trócares  
per trequarti

zerlegbar, 360° drehbar, für Titan-Clips  
detachable, 360° rotatable, for Titanium clips  
démontable, rotative de 360°, pour clips en titane  
desmontable, giratoria de 360°, para clips en titanio  
smontabile, rotante 360°, per clips di titanio

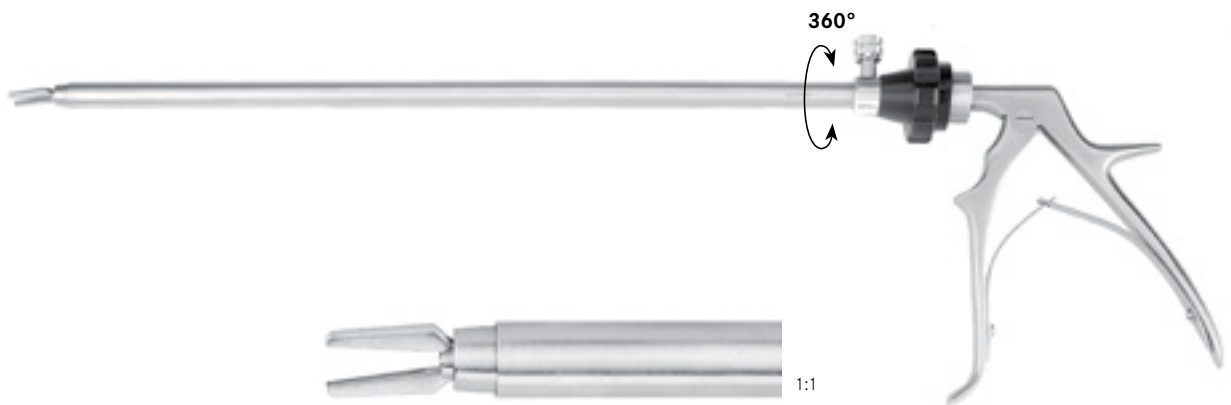

		Ø 10.0 mm - 330 mm
ETHICON - medium	Ø 10.0 mm	<b>tk 708-701</b>
ETHICON - medium/large	Ø 10.0 mm	<b>tk 708-702</b>
ETHICON - large	Ø 12.5 mm	<b>tk 708-703</b>
PILLING-WECK - small	Ø 10.0 mm	<b>tk 708-710</b>
PILLING-WECK - medium	Ø 10.0 mm	<b>tk 708-711</b>
PILLING-WECK - medium/large	Ø 10.0 mm	<b>tk 708-712</b>
PILLING-WECK - large	Ø 12.5 mm	<b>tk 708-713</b>

für Clips Typ  
for clips type  
pour clips, type  
para clips, tipo  
per clips tipo

für Trokare  
for trocars  
pour trocars  
para trócares  
per trequarti

360° drehbar, für Titan-Clips, mit LL-Spülkanal  
360° rotatable, for Titanium clips, with LL-rising channel  
rotative de 360°, pour clips en titane, avec connecteur LL  
giratoria de 360°, para clips en titanio, con conexión LL  
rotante 360°, per clips di titanio, con canale di lavaggio LL

**Clip Anlegezangen**  
*Clip application forceps*

Pinces à poser des clips  
*Pinzas para clips*  
Pinze per applicatore di clip



		Ø 10.0 mm - 330 mm	Ø 10.0 mm - 330 mm
ETHICON - small	Ø 10.0 mm	<b>tk 708-750</b>	-
ETHICON - medium	Ø 10.0 mm	<b>tk 708-751</b>	<b>tk 708-741</b>
ETHICON - medium/large	Ø 10.0 mm	<b>tk 708-752</b>	<b>tk 708-742</b>
ETHICON - large	Ø 12.5 mm	<b>tk 708-753</b>	<b>tk 708-743</b>
PILLING-WECK - small	Ø 10.0 mm	<b>tk 708-770</b>	-
PILLING-WECK - medium	Ø 10.0 mm	<b>tk 708-771</b>	<b>tk 708-761</b>
PILLING-WECK - medium/large	Ø 10.0 mm	<b>tk 708-772</b>	<b>tk 708-762</b>
PILLING-WECK - large	Ø 12.5 mm	<b>tk 708-773</b>	<b>tk 708-763</b>

für Clips Typ  
*for clips type*

pour clips, type  
*para clips, tipo*  
per clips tipo

für Trokare  
*for trocars*

pour trocars  
*para trócares*  
per trequarti

Einsatz, allein  
*Insert, only*  
Insert, seul  
*Inserto, solo*  
Inserto, solo

Zange komplett, zerlegbar, 360° drehbar  
*Forceps, complete, detachable, 360° rotatable*  
Pince complete, démontable, rotative de 360°  
*Pinza completa, desmontable, giratoria de 360°*  
Pinza completa, smontabile, rotante 360°

ETHICON clips - small	-	<b>tk 708-705 / LT 100</b>
ETHICON clips - medium	-	<b>tk 708-706 / LT 200</b>
ETHICON clips - medium/large	<b>tk 708-707 / LT 300</b>	-
ETHICON clips - large	<b>tk 708-708 / LT 400</b>	-

Pack mit 18 Magazinen à 6 Stck.  
*Pack with 18 magazines à 6 pcs.*  
Paquet de 18 magasins de 6 pcs  
*Paquetes. de 18 cargadores de 6 pzas*  
Confezione con 18 cartucce di 6 pezzi

Pack mit 36 Magazinen à 6 Stck.  
*Pack with 36 magazines à 6 pcs.*  
Paquet de 36 magasins de 6 pcs  
*Paquetes. de 36 cargadores de 6 pzas*  
Confezione con 36 cartucce di 6 pezzi

Endoretractoren | Endo-retracteurs  
*Endo-retractors* | *Endo-retractores*  
 Endo-retractor | Endo-retrattori



— x —

— x —



1:1



1:1

	x = 40 mm	x = 70 mm
Ø 5 mm - 360 mm	<b>tk 704-123</b>	<b>tk 704-124</b>
Ø 5 mm - 450 mm	<b>tk 704-123-45</b>	<b>tk 704-124-45</b>

Finger-Retractor  
*Finger retractor*  
 Rétracteur de doigts  
*Retractor de dedo*  
 Retrattore a dito

Triangular-Retractor  
*Triangular retractor*  
 Rétracteur triangulaire  
*Retractor triangular*  
 Retrattore triangolare



Endoretraktor, Elevator  
*Endo-retractor, elevator*

Endo-retracteur, elevateur  
*Endo-retractor, elevator*  
Retrattore, Elevatore



	450 mm	
Ø 5 mm	<b>tk 704-115</b>	<b>tk 704-125</b>

gerade <i>straight</i>	gebogen <i>curved</i>
droit <i>recto</i>	courbe <i>curva</i>
retto	curvo



	340 mm
Ø 5 mm	<b>tk 704-110</b>

Fächer-Retraktor (3 Finger) mit Spülvorrichtung  
*Fan-Retractor (3 fingers) with rinsing channel*

Retracteur en éventail, (3 doigts), avec connecteur LL  
*Retractor en abanico, (3 dedos), con conexión LL*  
Retrattore a ventaglio (3 lame), con LL



	336 mm
Ø 5 mm	<b>tk 704-111</b>

Fächer-Retraktor (3 Finger) mit Spülvorrichtung, abwinkelbar  
*Fan-Retractor (3 fingers) with rinsing channel, angleable*

Retracteur en éventail, (3 doigts), avec connecteur LL, pliable  
*Retractor en abanico, (3 dedos), con conexión LL, boca para doblar*  
Retrattore a ventaglio (3 lame), angolabile, con LL

**Endoretraktor, Elevator**  
*Endo-retractor, elevator*

Endo-retracteur, elevateur  
*Endo-retractor, elevator*  
 Retrattore, Elevatore



	380 mm
Ø 10 mm	<b>tk 704-112</b>

**Fächer-Retraktor (5 Finger) mit Spülvorrichtung**  
*Fan-Retractor (5 fingers) with rinsing channel*

Retracteur en éventail, (5 doigts), avec connecteur LL  
*Retractor en abanico, (5 dedos), con conexión LL*  
 Retrattore a ventaglio (5 lame), con LL

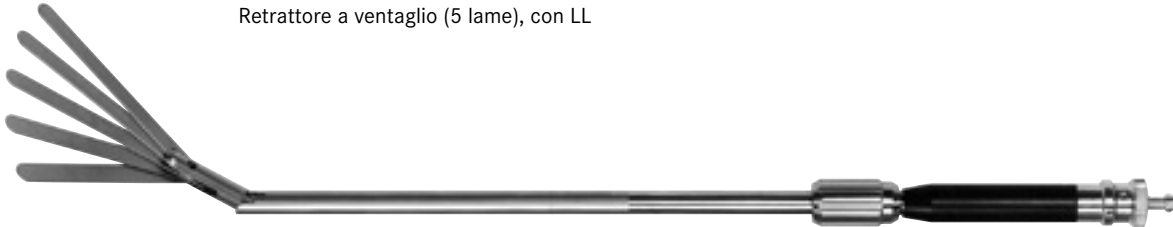

	347 mm
Ø 10 mm	<b>tk 704-113</b>





**Fächer-Retraktor (5 Finger) mit Spülvorrichtung, abwinkelbar**  
*Fan-Retractor (5 fingers) with rinsing channel, angleable*

Retracteur en éventail, (5 doigts), avec connecteur LL, pliable  
*Retractor en abanico, (5 dedos), con conexión LL, boca para doblar*  
 Retrattore a ventaglio (5 lame), angolabile, con LL

Elektroden, monopolar  
*Electrodes monopolar*

Electrodes monopolaires  
*Electrodos monopolares*  
Elettrodi monopolari



	Ø 2.8 mm		Ø 5.0 mm	
	250 mm	330 mm	330 mm	450 mm
 <b>Spatel</b> <i>Spatula</i> Spatule <i>Espátula</i> Spatola	<b>tk 762-103-25</b>	<b>tk 762-103</b>	<b>tk 706-152</b>	<b>tk 706-152-45</b>
 <b>Rundhaken</b> <i>Hook</i> Crochet <i>Gancho</i> Uncino	<b>tk 762-101-25</b>	<b>tk 762-101</b>	<b>tk 706-154</b>	<b>tk 706-154-45</b>
 <b>Haken 90°</b> <i>Hook 90°</i> Crochet 90° <i>Gancho 90°</i> Uncino 90°	<b>tk 762-102-25</b>	<b>tk 762-102</b>	<b>tk 706-156</b>	<b>tk 706-156-45</b>
 <b>Kugel</b> <i>Ball point</i> Boule <i>Bola</i> Sfera	<b>tk 762-104-25</b>	<b>tk 762-104</b>	<b>tk 706-158</b>	<b>tk 706-158-45</b>
 <b>Nadel</b> <i>Needle</i> Aiguille <i>Aguja</i> Ago	<b>tk 762-105-25</b>	<b>tk 762-105</b>	<b>tk 706-159</b>	<b>tk 706-159-45</b>

Elektrode, monopolar, massive Ausführung  
*Electrode, monopolar, solid model*  
 Electrode, monopolaire, modèle solide  
*Electrodo, monopolar, modelo sólido*  
 Elettrodi, monopolari, modello solido



**tk 706-150**

Komfort-Handgriff für Elektroden (tk 706-152 - tk 706-158)  
*Comfort-handle for electrodes (tk 706-152 - tk 706-158)*  
 Poignée de confort pour électrodes (tk 706-152 - tk 706-158)  
*Mango de confort para electrodos (tk 706-152 - tk 706-158)*  
 Manico confortabile per elettrodi (tk 706-152 - tk 706-158)

**Elektroden mit auswechselbaren Spitzen**  
*Electrodes with interchangeable tips*

**Electrodes avec inserts interchangeable**  
*Electrodo con insertos intercambiables*  
 Elettrodi con punte intercambiabili



**tk 706-170**

**Schaft und Griff**  
*Shaft and handle*

Tige et poignée  
 Vaina y mango  
 Asta e manico

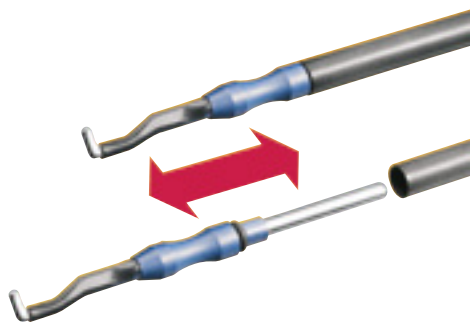

Ø 5.0 mm - ~350 mm		
<b>Haken 90°</b> <i>Hook 90°</i> Crochet 90° <i>Gancho 90°</i> Uncino 90°	<b>tk 706-191</b>	<b>tk 706-171</b>
<b>Spatel, kurz</b> <i>Spatula, short</i> Spatule, courte <i>Espátula, corta</i> Spatola	<b>tk 706-192</b>	<b>tk 706-172</b>
<b>Draht</b> <i>Wire hook</i> Crochet fin <i>Gancho fino</i> Uncino fine	<b>tk 706-193</b>	<b>tk 706-173</b>
<b>Knopf</b> <i>Ball point</i> Boule <i>Bola</i> <i>Sfera</i>	<b>tk 706-194</b>	<b>tk 706-174</b>
<b>Spatel</b> <i>Spatula</i> Spatule <i>Espátula</i> Spatola	<b>tk 706-195</b>	<b>tk 706-175</b>
<b>Rundhaken</b> <i>Round hook</i> Crochet rond <i>Gancho redondo</i> Uncino rotondo	<b>tk 706-196</b>	<b>tk 706-176</b>

**komplett**  
*complete*  
 complet  
*completo*  
 completo







**Einsatz, allein**  
*Insert, only*  
 Insert, seul  
*Inserto, solo*  
 Inserto, solo



Monopolare Hochfrequenzkabel  
*Monopolar high frequency cables*

Cables monopolaires  
*Cables monopolares*  
 Cavi monopolari

autoklavierbar / *autoclavable*  
 134°C / 273°F

	TEKNO, Berchtold, Martin, Erbe T-series	3 m	<b>tk 707-510</b>	
		5 m	<b>tk 707-511</b>	
	TEKNO, Storz, Erbe, Martin, Berchtold	3 m	<b>tk 707-520</b>	
		5 m	<b>tk 707-521</b>	
	Valleylab	3 m	<b>tk 707-525</b>	
		5 m	<b>tk 707-526</b>	







Geräteseite  
*Units side*  
 Coté appareil  
*Lado equipo*  
 Lato apparecchio

Instrumentenseite  
*Instrument side*  
 Coté instrument  
*Lado instruments*  
 Lato strumento

**Bipolare Koagulationselektroden**  
*Bipolar coagulation electrodes*

Electrodes à coagulation bipolaire  
*Electrodos para la coagulación bipolar*  
Elettrodi per coagulazione bipolare

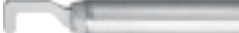















	Ø 3.0mm	x = 340mm
 1:1	<b>L-Haken</b> <i>L-hook</i> Crochet en L <i>Gancho L</i> Uncino L	<b>tk 707-160</b>
 1:1	<b>V-Haken</b> <i>V-hook</i> Crochet en V <i>Gancho V</i> Uncino V	<b>tk 707-161</b>
 1:1	<b>Nadel</b> <i>Needle</i> Aiguille <i>Aguja</i> Ago	<b>tk 707-162</b>
	Ø 5.0mm	x = 340mm
 1:1	<b>Rundhaken</b> <i>Hook</i> Crochet <i>Gancho</i> Uncino	<b>tk 707-150</b>
 1:1	<b>Haken 90°</b> <i>Hook 90°</i> Crochet 90° <i>Gancho 90°</i> Uncino 90°	<b>tk 707-151</b>
 1:1	<b>Spatel</b> <i>Spatula</i> Spatule <i>Espátula</i> Spatola	<b>tk 707-152</b>
 1:1	<b>Knopf</b> <i>Ball point</i> Boule <i>Bola</i> Sfera	<b>tk 707-153</b>

Bipolare Instrumentenkabel  
Bipolar instrument cables

Cables bipolaires  
Cables bipolares  
Cavi bipolari

Hochfrequenzkabel, 3 m  
High frequency cable, 3 m  
Câble de haute fréquence, 3 m  
Cable alta frecuencia, 3 m  
Cavo ad alta frequenza, 3 m

autoclavable  
134°C / 273°F

	Erbe ICC/ACC, Wisap, Storz	tk 707-330	Flat plug round	
		tk 707-300	Flat plug square	
	Martin, Berchtold	tk 707-331	Flat plug round	
		tk 707-301	Flat plug square	
	TEKNO, Valleylab USA	tk 707-332	Flat plug round	
		tk 707-302	Flat plug square	
	TEKNO, Valleylab Europe	tk 707-333	Flat plug round	
		tk 707-303	Flat plug square	
	TEKNO, 19 mm for TOM 80/100 212/212A/ 412/412A only	tk 707-338	Flat plug round	

Geräteseite  
Unit side

Coté appareil  
Lado equipo  
Lato elettrobisturi

Instrumentenseite  
Instrument side

Coté instrument  
Lado instrumento  
Lato strumento



Andere Anschlüsse auf Anfrage lieferbar  
Other connectors are available upon request

Autres raccords sont disponibles sur demande  
Otras conexiones son disponibles según demanda  
Altri attacchi a richiesta



**Ring Applikatoren**  
*Ring applicators*

Applicateurs des anneaux  
*Aplicadores de anillos*  
Applicatore per anelli

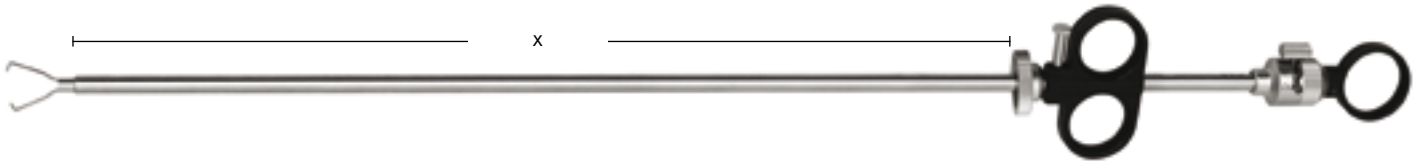

	x = 332 mm
Ø 6 mm - 18 Charr.	<b>tk 791-180</b>

Zur Anwendung mit OP-Laparoskop tk 700-250.  
Für einen Einstich; komplett mit Ladevorrichtung und Konusteil.  
*For use with OP-Laparoscope tk 700-250.*  
*For single puncture; complete with loading device and cone part.*  
Pour l'utilisation avec laparoscope tk 700-250.  
Pour une ponction; complet avec chargeur et conus.  
*Para la utilización con laparoscop tk 700-250.*  
*Para una punción; completo con cargador y punta conica.*  
Per utilizzo con laparoscopio operativo tk 700-250.  
Per singola incisione; completo di strumenti di carica e parte a cono.

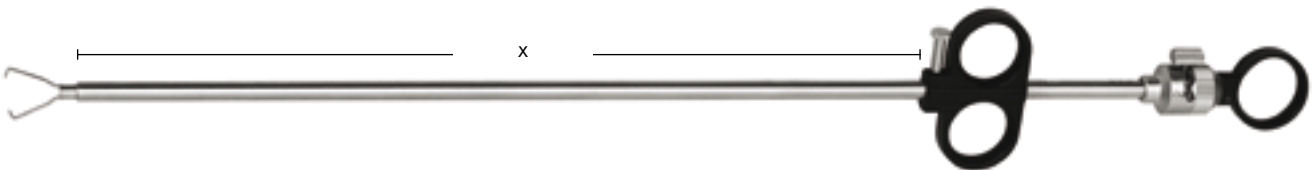

	x = 287 mm
Ø 6.5 mm - 20 Charr.	<b>tk 791-185</b>

Zur Anwendung mit einer regulären Trokarhülse (7 mm).  
Für den zweiten Einstich; komplett mit Ladevorrichtung und Konusteil.  
*For use with a regular trocar sheath (7 mm).*  
*For second puncture; complete with loading device and cone part.*  
Pour l'utilisation avec un trocar standard (7 mm).  
Pour la deuxième ponction; complet avec chargeur et conus.  
*Para la utilización con un trocar estandard (7 mm).*  
*Para segundo punción, completo con cargador y punta conica.*  
Per utilizzo con trocar normale (7 mm).  
Per due incisioni; completo di strumenti di carica e parte a cono.



**tk 791-187**

Konusteil für tk 791-180 / tk 791-185  
*Cone part for tk 791-180 / tk 791-185*  
Conus pour tk 791-180 / tk 791-185  
*Punta conica para tk 791-180 / tk 791-185*  
Parte conica per tk 791-180 / tk 791-185



**tk 791-189**

Ladevorrichtung für tk 791-180 / tk 791-185  
*Loading device for tk 791-180 / tk 791-185*  
Chargeur pour tk 791-180 / tk 791-185  
*Cargador para tk 791-180 / tk 791-185*  
Caricatore per tk 791-180 / tk 791-185

Uterusmanipulator | Manipulator utérin  
*Uterus manipulator* | *Manipulador uterino*  
 Manipolatore uterino

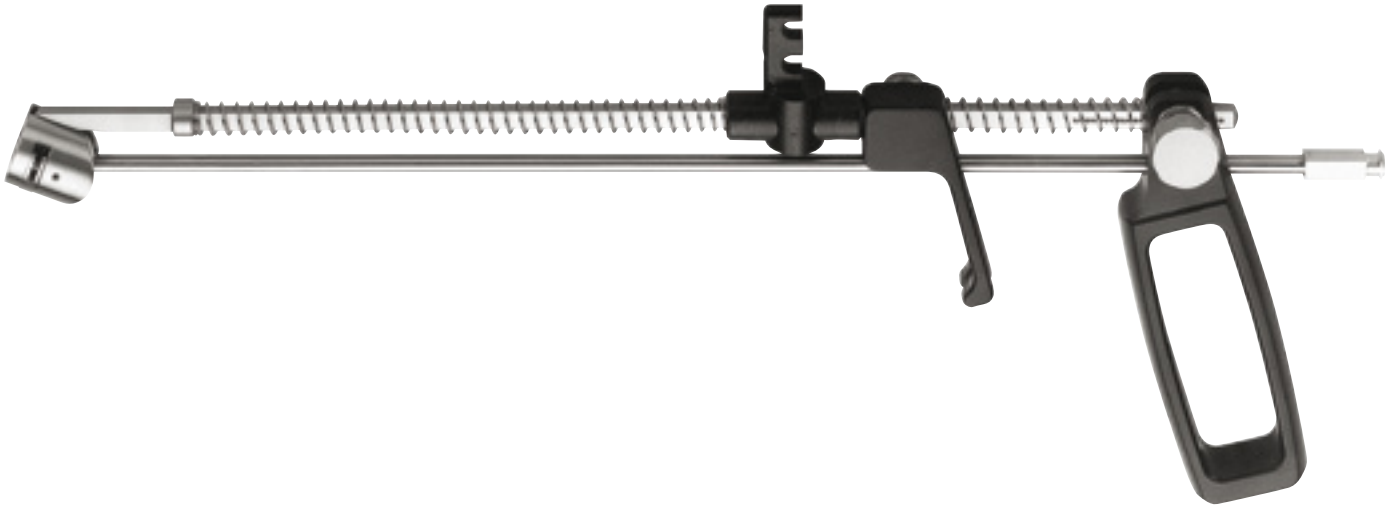

	<b>tk 791-151</b>	<b>tk 791-152</b>	<b>tk 791-153</b>	<b>tk 791-154</b>	<b>tk 791-155</b>	<b>tk 791-156</b>	<b>tk 791-157</b>
<b>Manipulator</b> <i>Manipulator</i> Manipulator <i>Manipulador</i> Manipolatore		Ø 3.0 x 45 mm	Ø 3.0 x 55 mm	Ø 3.2 x 34 mm	Ø 3.2 x 45 mm	Ø 8.0 x 80 mm	Ø 10.0 x 100 mm
<b>tk 791-150</b>	<b>x</b>	<b>x</b>	<b>x</b>	<b>x</b>	<b>x</b>	<b>x</b>	<b>x</b>

14  
 komplett  
*complete*  
 complet  
*completo*  
 completo

Instrumente  
Instruments

Instruments  
Instrumentos  
Strumenti

Myombohrer  
*Myoma drill*  
Mèche pour myomes  
*Taladro para miomas*  
Fissatore per mioma



	x = 330 mm	x = 420 mm
Ø 5.0 mm	<b>tk 791-170</b>	<b>tk 791-176</b>



	x = 330 mm	x = 420 mm
Ø 10.0 mm	<b>tk 791-174</b>	<b>tk 791-175</b>

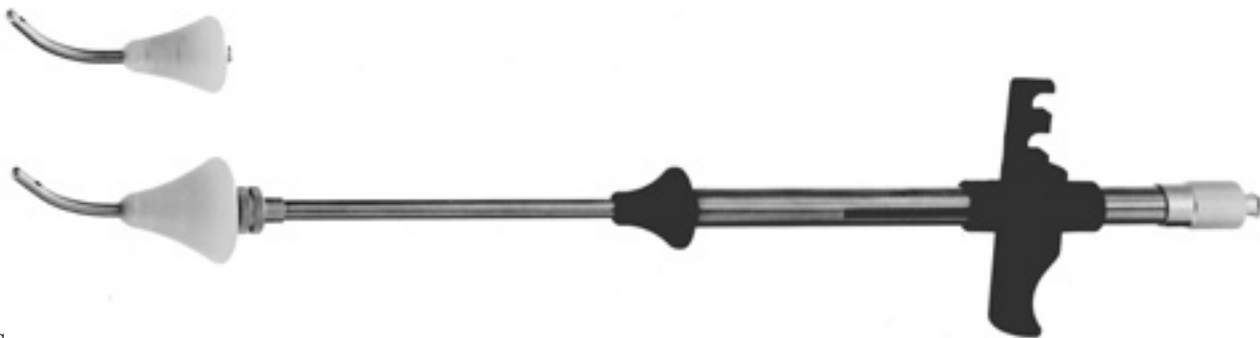

COHEN  
**tk 791-161**

Intra-Uterin-Sonde mit 1 kleinen und 1 großen Portio-Kegelansatz  
*Intra-uterine probe with 1 small and 1 large cervical cone*  
Sonde intra utérin avec 1 petit et 1 grand adaptateur conique  
*Sonda intra-uterina con 1 pequeño y 1 grande adaptador conico*  
Sonda intra-uterina con un cono cervicale piccolo ed uno grande

Reinigungs- und Sterilisationszubehör  
*Cleaning and sterilizing accessories*

Accessoires pour nettoyage et stérilisation  
*Accesorios para limpieza y esterilización*  
Accessori per pulizia e sterilizzazione



**tk 707-600**

Reinigungspistole komplett mit 9 Adaptern  
*Cleaning gun complete with 9 adaptors*

Pistolet de nettoyage avec 9 adaptateurs  
*Pistola de limpieza con 9 adaptadores*  
Pistola per pulire completa di 9 adattatori

	480 mm
Ø 3 mm	<b>tk 707-604</b>
Ø 5 mm	<b>tk 707-605</b>
Ø 10 mm	<b>tk 707-610</b>

für Ø Rohr  
*for Ø tube*

Reinigungsbürste (10 Stück)  
*Cleaning brush (10 pieces)*

pour Ø tube  
*para Ø tubos*  
per Ø tubi

Brosse de nettoyage (10 pièces)  
*Cepillo de limpieza (10 piezas)*  
Spazzolini (10 pezzi)

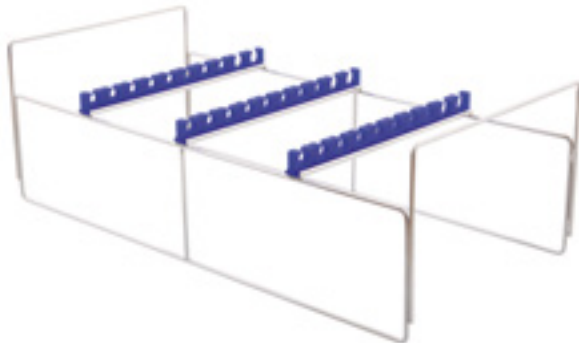

**tk 87295-00**

Halter für Laparoskopie-Instrumente (490 x 235 x 160 mm)  
*Sterilization tray for laparoscopy instruments (490 x 235 x 160 mm)*  
Support pour instruments de coelioscopie (490 x 235 x 160 mm)  
*Soporte para instrumentos de laparoscopia (490 x 235 x 160 mm)*  
Sostegno per strumenti di laparoscopia (490 x 235 x 160 mm)



**tk 87015-20**

Siebkorb (510 x 255 x 50 mm) für tk 87295-00  
*Wire basket (510 x 255 x 50 mm) for tk 87295-00*  
Panier (510 x 255 x 50 mm) pour tk 87295-00  
*Cesta (510 x 255 x 50 mm) para tk 87295-00*  
Cestello (510 x 255 x 50 mm) per tk 87295-00



**tk 87200-1F-SI**

Container für tk 87295-00  
*Container for tk 87295-00*  
Contenaire pour tk 87295-00  
*Contenedor para tk 87295-00*  
Container per tk 87295-00

**Reinigungs- und Sterilisationszubehör**  
*Cleaning and sterilizing accessories*

**Accessoires pour nettoyage et stérilisation**  
*Accesorios para limpieza y esterilización*  
**Accessori per pulizia e sterilizzazione**



Perforierter Boden und Deckel, ohne Filter.  
Silikonhalterungen für zwei Endoscope.

*Perforated bottom and lid, without filter.*  
*Silicon fittings for two endoscopes.*

Couvercle et fond perforés, sans filtres.  
Pièces en silicou pour 2 optiques.

*Tapa y fondo perforados, sin filtros.*  
*Piezas en silicona para 2 ópticas.*

Coperchio e fondo perforato, senza filtri.  
Sostegno di silicone per 2 ottiche.

250 x 60 x 50 mm		<b>tk 87280-2F-SI</b>
250 x 60 x 50 mm		<b>tk 87280-2F-YE</b>
250 x 60 x 50 mm		<b>tk 87280-2F-GR</b>
250 x 60 x 50 mm		<b>tk 87280-2F-BL</b>
250 x 60 x 50 mm		<b>tk 87280-2F-RE</b>
250 x 60 x 50 mm		<b>tk 87280-2F-BK</b>

Deckelfarbe  
*Lid colour*  
Couleur du couvercle  
*Color de la tapa*  
Colore del coperchio

450 x 70 x 70 mm		<b>tk 87290-2F-SI</b>
450 x 70 x 70 mm		<b>tk 87290-2F-YE</b>
450 x 70 x 70 mm		<b>tk 87290-2F-GR</b>
450 x 70 x 70 mm		<b>tk 87290-2F-BL</b>
450 x 70 x 70 mm		<b>tk 87290-2F-RE</b>
450 x 70 x 70 mm		<b>tk 87290-2F-BK</b>

Deckelfarbe  
*Lid colour*  
Couleur du couvercle  
*Color de la tapa*  
Colore del coperchio



460 x 80 x 52 mm	<b>tk 707-650</b>
290 x 80 x 52 mm	<b>tk 707-651</b>

Siebkorb für Optiken > ø 2,7mm  
*Wire basket for endoscopes > ø 2.7 mm*  
Panier pour optiques > ø 2,7 mm  
*Cesta para ópticas > ø 2,7 mm*  
Cestello per endoscopi con diametro > ø 2,7 mm



**tk 700-999**

Autoklavierbare Schutzhülse für Endoskope bis Ø 5 mm, durch Zusammenstecken von 2 Hülseu erweiterbar für Urologie / Laparoskopie / Gynäkologie - Optiken  
*Autoclavable protection tube for endoscopes up to Ø 5 mm, assembling of two tubes will allow a protection for Urology / Laparoscopy / Gynaecology scopes*

Gaines de protection autoclavables pour optiques jusqu'au 5mm Ø. En combinant deux gaines, élargable pour des optiques d'urologie / laparoscopie et gynécologie.  
*Vainas de protección autoclavables para ópticas fino a Ø 5mm. Conectando dos vainas se pueden utilizar también para ópticas de Urología / Laparoscopia / Ginecología*  
Tubi di protezione autoclavabili per ottiche fino a 5 mm di diametro. L'assemblaggio di due tubi consentirà la protezione di ottiche per urologia/laparoscopia/ginecologia

Ersatzteile, Pflegemittel  
Spare parts, detergents for instruments

Pièces de réchange, détergents  
Piezas de recambio, detergentes  
Pezzi di ricambio, detergenti



	30 ml	25 ml	15 ml
	<b>tk 95000-50</b>	<b>tk 95000-51</b>	<b>tk 95000-52</b>
Antibeslagmittel <i>Antifog solution</i>	Durchstichflasche (steril) <i>Pierce bottle (sterile)</i>	Pipettenflasche <i>Pipette bottle</i>	Sprühflasche <i>Spray bottle</i>
Solution antibuée <i>Solución antiraho</i>	Bouteille perforée (stérile) <i>Botella perforada (estéril)</i>	Bouteille pipette <i>Botella con pipeta</i>	Bouteille spray <i>Botella de spray</i>
Anti appannante	Bottiglia perforabile (sterile)	Bottiglia con pipetta	Bottiglia spray



	<b>tk 95011-00</b>	<b>tk 95011-02</b>	<b>tk 95012-00</b>
LL-Verschlusschrauben <i>End screws for LL channels</i>	Kunststoff, weiß <i>Plastic, white</i>	Kunststoff, schwarz <i>Plastic, black</i>	Edelstahl <i>Stainless steel</i>
Vis pour connecteur LL <i>Tornillos para conexión LL</i>	Plastifié, blanc <i>Plástico blanco</i>	Plastifié, noir <i>Plástico negro</i>	Acier inoxydable <i>Acero inoxidable</i>
Tappi di chiusura LL	Plastica bianca	Plastica nero	Acciaio inossidabile



**tk 95010-00**

Dichtungskappe, Silikon (10 Stück)  
*Silicon cap (10 pieces)*  
Capuchon de silicon (10 pièces)  
*Capuchón de silicona (10 piezas)*  
Cappuccio in silicone (10 pezzi)



500 ml	100 ml
<b>tk 95000-00</b>	<b>tk 95100-00</b>

TEKNO Spezial-Öl zur Instrumentenpflege  
*TEKNO special oil for surgical instruments*  
TEKNO hulieux pour des instruments  
*TEKNO aceite para instrumentos*  
TEKNO olio speciale per strumentario chirurgico

**Ersatzteile, Pflegemittel**  
*Spare parts, detergent for instruments*

Pièces de réchange, détergents  
*Piezas de recambio, detergentes*  
 Pezzi di ricambio, detergenti

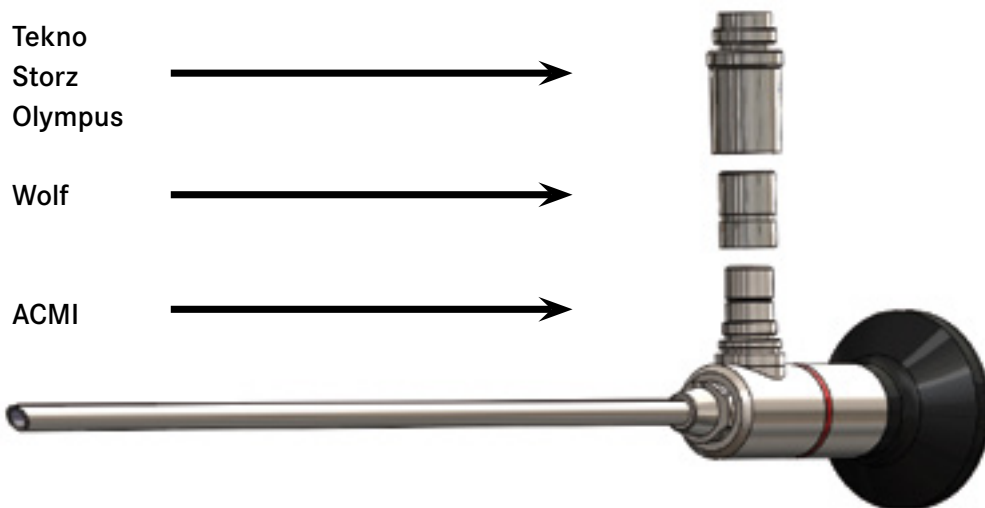

**tk 700-997**

Adapter für TEKNO Optiken zum Anschluss von TEKNO, Storz und Olympus Kaltlichtkabeln.  
*Adaptor for TEKNO endoscopes to connect TEKNO, Storz, Olympus cold light cables.*

Adaptateur pour connecter des optiques TEKNO avec des cables de lumière froide TEKNO, Storz, Olympus  
*Adaptador para la conexión de las ópticas TEKNO con los cables de luz fría de TEKNO, Storz, Olympus*  
 Adattatore per ottiche TEKNO per la connessione con cavi di luce fredda TEKNO, Storz ed Olympus



**tk 700-998**

Adapter für TEKNO Optiken zum Anschluss von Wolf Kaltlichtkabeln.  
*Adaptor for TEKNO endoscopes to connect Wolf cold light cables.*

Adaptateur pour connecter des optiques TEKNO avec des cables de lumière froide Wolf  
*Adaptador para la conexión de las ópticas TEKNO con los cables de luz fría de Wolf*  
 Adattatore per ottiche TEKNO per la connessione con cavi di luce fredda Wolf



Nummernverzeichnis  
*Numerical Index*

Index numérique  
*Indice numerico*  
Indice dei numeri d'articolo

Art. No.	Page	Art. No.	Page	Art. No.	Page	Art. No.	Page
tk 700-000	8	tk 704-0018	23	tk 704-088	20	tk 704-238	22
tk 700-001	8	tk 704-0020	23	tk 704-090	20	tk 704-240	21
tk 700-002	8	tk 704-0021	23	tk 704-092	19	tk 704-241	21
tk 700-003	8	tk 704-0022	22	tk 704-093	19	tk 704-242	21
tk 700-004	8	tk 704-0023	22	tk 704-095	26	tk 704-243	21
tk 700-011	8	tk 704-0024	22	tk 704-096	26	tk 704-244	21
tk 700-012	8	tk 704-0025	22	tk 704-098	26	tk 704-245	21
tk 700-020	8	tk 704-0026	22	tk 704-100	26	tk 704-295	15
tk 700-023	8	tk 704-0027	22	tk 704-101	26	tk 704-308	16
tk 700-024	8	tk 704-006	19	tk 704-104	26	tk 704-360	5
tk 700-028	8	tk 704-006-15	19	tk 704-106	72	tk 704-360	15
tk 700-029	8	tk 704-012-15	19	tk 704-107	72	tk 704-362	17
tk 700-030	9	tk 704-0122	23	tk 704-108	72	tk 704-365	15
tk 700-033	9	tk 704-0123	23	tk 704-109	51	tk 704-367	18
tk 700-203	9	tk 704-0124	23	tk 704-109 C	51	tk 704-368	18
tk 700-204	9	tk 704-0124	23	tk 704-109 CS	51	tk 704-389 K	22
tk 700-205	9	tk 704-0124	23	tk 704-109-25	51	tk 704-390 K	22
tk 700-250	10	tk 704-0124	23	tk 704-109-25 C	51	tk 704-395 K	22
tk 700-251	10	tk 704-0127	23	tk 704-109-25 CS	51	tk 704-397 K	22
tk 700-255	10	tk 704-0127	23	tk 704-109-45	51	tk 704-398 K	22
tk 700-256	10	tk 704-0128	23	tk 704-109-45 C	51	tk 704-399 K	22
tk 700-275	9	tk 704-0129	23	tk 704-109-45 CS	51	tk 704-4002-15	15
tk 700-275SF	9	tk 704-014	19	tk 704-110	82	tk 704-4010-15	15
tk 700-276	9	tk 704-015	19	tk 704-111	82	tk 704-4012-15	15
tk 700-276SF	9	tk 704-016	19	tk 704-112	83	tk 704-436	21
tk 700-300	8	tk 704-016-15	19	tk 704-113	83	tk 704-437	21
tk 700-301	8	tk 704-018	19	tk 704-115	82	tk 704-438	21
tk 700-302	8	tk 704-020	19	tk 704-120	29	tk 704-439	21
tk 700-310	8	tk 704-0200	23	tk 704-121	29	tk 704-440	21
tk 700-311	8	tk 704-0200A	23	tk 704-122	29	tk 704-580	28
tk 700-312	8	tk 704-0200A	23	tk 704-123	81	tk 704-582	28
tk 700-420	8	tk 704-0201	23	tk 704-123-45	81	tk 704-602	29
tk 700-423	8	tk 704-0201A	23	tk 704-124	81	tk 704-603	29
tk 700-424	8	tk 704-0201A	23	tk 704-124-45	81	tk 704-605	28
tk 700-430	8	tk 704-0202	23	tk 704-125	82	tk 704-607	28
tk 700-433	8	tk 704-0204	23	tk 704-150	26	tk 704-608	28
tk 700-450	8	tk 704-0204	23	tk 704-151	26	tk 704-609	28
tk 700-453	8	tk 704-0205	23	tk 704-152	26	tk 704-610	28
tk 700-990	11	tk 704-022	19	tk 704-154	26	tk 704-642	27
tk 700-997	95	tk 704-022-15	19	tk 704-156	26	tk 704-644	27
tk 700-998	95	tk 704-026	19	tk 704-157	26	tk 704-646	27
tk 700-999	93	tk 704-026-15	19	tk 704-160	20	tk 704-650	27
tk 701-022	78	tk 704-027-15	19	tk 704-161	20	tk 704-652	27
tk 703-100 LL	78	tk 704-028	19	tk 704-162	20	tk 704-654	27
tk 703-102 LL	78	tk 704-029	19	tk 704-200	21	tk 704-656	27
tk 703-510 LL	78	tk 704-031	19	tk 704-203	21	tk 704-658	27
tk 703-512 LL	78	tk 704-033	19	tk 704-204	21	tk 704-660	27
tk 704-000	21	tk 704-035	19	tk 704-207	21	tk 704-662	27
tk 704-0002	23	tk 704-036	19	tk 704-216	21	tk 704-670	15
tk 704-0004	23	tk 704-060	20	tk 704-217	21	tk 704-671	15
tk 704-0004	23	tk 704-061	20	tk 704-218	21	tk 704-672	15
tk 704-0004A	23	tk 704-065	20	tk 704-220	25	tk 704-673	15
tk 704-0006	23	tk 704-067	20	tk 704-221	25	tk 704-674	15
tk 704-0008	23	tk 704-070	19	tk 704-222	25	tk 704-675	15
tk 704-0008	23	tk 704-072	19	tk 704-223	25	tk 704-676	15
tk 704-0008	23	tk 704-076	20	tk 704-224	25	tk 704-677	15
tk 704-0010	23	tk 704-077	20	tk 704-225	25	tk 704-678	15
tk 704-0010	23	tk 704-078	20	tk 704-233	21	tk 704-679	17
tk 704-0013	23	tk 704-087	20	tk 704-235	22	tk 704-680	17

**Nummernverzeichnis**  
*Numerical Index*

Index numérique  
*Indice numerico*  
Indice dei numeri d'articolo

Art. No.	Page	Art. No.	Page	Art. No.	Page	Art. No.	Page
tk 704-681	17	tk 706-176	85	tk 707-041	66	tk 707-161	87
tk 704-682	17	tk 706-180	33	tk 707-042	66	tk 707-162	87
tk 704-683	17	tk 706-180-45	33	tk 707-044	67	tk 707-170	71
tk 704-684	17	tk 706-182	33	tk 707-045	67	tk 707-170-45	71
tk 704-685	17	tk 706-182-45	33	tk 707-046	67	tk 707-171	71
tk 704-686	17	tk 706-184	33	tk 707-047	67	tk 707-171-45	71
tk 704-687	14	tk 706-184-45	33	tk 707-070	71	tk 707-172	71
tk 704-688	14	tk 706-186	33	tk 707-070-45	71	tk 707-173	71
tk 704-689	14	tk 706-186-45	33	tk 707-071	71	tk 707-173-45	71
tk 704-690	14	tk 706-187	33	tk 707-071-45	71	tk 707-300	88
tk 704-691	14	tk 706-187-45	33	tk 707-072	71	tk 707-301	88
tk 704-692	14	tk 706-191	85	tk 707-073	71	tk 707-302	88
tk 704-693	14	tk 706-192	85	tk 707-073-45	71	tk 707-303	88
tk 704-694	14	tk 706-193	85	tk 707-100 ZDR	68	tk 707-330	88
tk 704-715	30	tk 706-194	85	tk 707-101 ZDR	68	tk 707-331	88
tk 704-720	30	tk 706-195	85	tk 707-103 ZDR	68	tk 707-332	88
tk 704-721	30	tk 706-196	85	tk 707-105 ZDR	68	tk 707-333	88
tk 704-722	30	tk 707-000 E	68	tk 707-106 ZDR	68	tk 707-338	88
tk 704-730	30	tk 707-000 ZDR	68	tk 707-108 ZDR	69	tk 707-340	66
tk 704-731	30	tk 707-001 E	68	tk 707-109 ZDR	69	tk 707-341	66
tk 704-732	30	tk 707-001 ZDR	68	tk 707-112 ZDR	65	tk 707-342	66
tk 704-745	30	tk 707-003 E	68	tk 707-113 ZDR	65	tk 707-343	66
tk 704-750	31	tk 707-003 ZDR	68	tk 707-120	70	tk 707-510	86
tk 704-751	31	tk 707-005 E	68	tk 707-120-25	70	tk 707-511	86
tk 704-752	31	tk 707-005 ZDR	68	tk 707-120-45	70	tk 707-520	86
tk 704-752-45	31	tk 707-006 E	68	tk 707-121	70	tk 707-521	86
tk 704-753	31	tk 707-006 ZDR	68	tk 707-121-25	70	tk 707-525	86
tk 704-753-45	31	tk 707-008 E	69	tk 707-121-45	70	tk 707-526	86
tk 704-760	31	tk 707-008 ZDR	69	tk 707-122	70	tk 707-600	92
tk 704-761	32	tk 707-009 E	69	tk 707-122-45	70	tk 707-604	92
tk 704-762	32	tk 707-009 ZDR	69	tk 707-123	70	tk 707-605	92
tk 704-763	32	tk 707-010	69	tk 707-123-45	70	tk 707-610	92
tk 704-764	32	tk 707-012 E	65	tk 707-124	70	tk 707-650	93
tk 704-765	32	tk 707-012 ZDR	65	tk 707-124-25	70	tk 707-651	93
tk 704-800	25	tk 707-013	69	tk 707-124-45	70	tk 708-100 LL	77
tk 704-801	25	tk 707-013 E	65	tk 707-125	70	tk 708-110 LL	77
tk 704-802	25	tk 707-013 ZDR	65	tk 707-125-25	70	tk 708-511 LL	77
tk 704-803	25	tk 707-014	69	tk 707-125-45	70	tk 708-512 LL	77
tk 705-001	72	tk 707-015	69	tk 707-126	70	tk 708-513 LL	77
tk 705-002	72	tk 707-016	69	tk 707-126-45	70	tk 708-520	76
tk 705-004	72	tk 707-020	70	tk 707-131	70	tk 708-521	76
tk 705-005	72	tk 707-020-25	70	tk 707-131-25	70	tk 708-522	76
tk 706-150	84	tk 707-020-45	70	tk 707-131-45	70	tk 708-530	77
tk 706-152	84	tk 707-021	70	tk 707-132	70	tk 708-540	74
tk 706-152-45	84	tk 707-021-25	70	tk 707-133	71	tk 708-541	74
tk 706-154	84	tk 707-021-45	70	tk 707-133-45	71	tk 708-542	74
tk 706-154-45	84	tk 707-022	70	tk 707-134	71	tk 708-543	74
tk 706-156	84	tk 707-022-45	70	tk 707-140	67	tk 708-544	74
tk 706-156-45	84	tk 707-023	70	tk 707-141	67	tk 708-545	74
tk 706-158	84	tk 707-023-45	70	tk 707-142	67	tk 708-546	74
tk 706-158-45	84	tk 707-024	70	tk 707-144	67	tk 708-547	74
tk 706-159	84	tk 707-024-25	70	tk 707-145	67	tk 708-548	74
tk 706-159-45	84	tk 707-024-45	70	tk 707-146	67	tk 708-549	74
tk 706-170	85	tk 707-025	70	tk 707-147	67	tk 708-550	74
tk 706-171	85	tk 707-025-25	70	tk 707-150	87	tk 708-551	74
tk 706-172	85	tk 707-025-45	70	tk 707-151	87	tk 708-552	74
tk 706-173	85	tk 707-026	70	tk 707-152	87	tk 708-553	74
tk 706-174	85	tk 707-026-45	70	tk 707-153	87	tk 708-554	74
tk 706-175	85	tk 707-040	66	tk 707-160	87	tk 708-555	74

**Nummernverzeichnis**  
*Numerical Index*
**Index numérique**  
*Indice numerico*
**Indice dei numeri d'articolo**

Art. No.	Page	Art. No.	Page	Art. No.	Page	Art. No.	Page
tk 708-556	74	tk 708-773	80	tk 775-4004	35	tk 775-4025 C	44
tk 708-557	74	tk 712-440	24	tk 775-4005	35	tk 775-4025-25	44
tk 708-558	74	tk 712-441	24	tk 775-4006	36	tk 775-4025-25 C	44
tk 708-559	74	tk 712-442	24	tk 775-4009	37	tk 775-4025-45	44
tk 708-560	74	tk 712-443	24	tk 775-4010	37	tk 775-4025-45 C	44
tk 708-561	74	tk 712-450	24	tk 775-4010-45LL	37	tk 775-4026	44
tk 708-562	74	tk 712-451	24	tk 775-4010LL	37	tk 775-4026 C	44
tk 708-563	74	tk 712-452	24	tk 775-4011	37	tk 775-4026 TS	42
tk 708-564	74	tk 712-453	24	tk 775-4012	37	tk 775-4026 TSC	42
tk 708-565	74	tk 712-460	24	tk 775-4012-25	37	tk 775-4026 TSCM	42
tk 708-566	74	tk 712-461	24	tk 775-4012-45	37	tk 775-4026-25	44
tk 708-567	74	tk 712-462	24	tk 775-4013	37	tk 775-4026-25 C	44
tk 708-568	74	tk 712-463	24	tk 775-4014	37	tk 775-4026-25 TS	42
tk 708-569	74	tk 712-470	24	tk 775-4015	37	tk 775-4026-25 TSC	42
tk 708-570	74	tk 712-471	24	tk 775-4016	37	tk 775-4026-25 TSCM	42
tk 708-571	74	tk 712-472	24	tk 775-4020	44	tk 775-4026-45	44
tk 708-634	75	tk 712-473	24	tk 775-4020 C	44	tk 775-4026-45 C	44
tk 708-635	75	tk 730-160	13	tk 775-4020 TS	42	tk 775-4026-45 TS	42
tk 708-636	75	tk 730-161	19	tk 775-4020 TSC	42	tk 775-4026-45 TSC	42
tk 708-637	75	tk 730-162	19	tk 775-4020 TSCM	42	tk 775-4026-45 TSCM	42
tk 708-638	75	tk 730-170	13	tk 775-4020-25	44	tk 775-4027	44
tk 708-639	75	tk 730-171	19	tk 775-4020-25 C	44	tk 775-4027 C	44
tk 708-640	75	tk 730-172	19	tk 775-4020-25 TS	42	tk 775-4027 TS	42
tk 708-641	75	tk 730-210	17	tk 775-4020-25 TSC	42	tk 775-4027 TSC	42
tk 708-644	75	tk 730-220	19	tk 775-4020-25 TSCM	42	tk 775-4027 TSCM	42
tk 708-645	75	tk 754-159	26	tk 775-4020-45	44	tk 775-4027-25	44
tk 708-648	75	tk 760-000	25	tk 775-4020-45 C	44	tk 775-4027-25 C	44
tk 708-649	75	tk 760-000-25	25	tk 775-4020-45 TS	42	tk 775-4027-25 TS	42
tk 708-652	75	tk 762-101	84	tk 775-4020-45 TSC	42	tk 775-4027-25 TSC	42
tk 708-653	75	tk 762-101-25	84	tk 775-4020-45 TSCM	42	tk 775-4027-25 TSCM	42
tk 708-656	75	tk 762-102	84	tk 775-4021	52	tk 775-4027-45	44
tk 708-657	75	tk 762-102-25	84	tk 775-4021 C	52	tk 775-4027-45 C	44
tk 708-660	75	tk 762-103	84	tk 775-4021 CS	52	tk 775-4027-45 TS	42
tk 708-661	75	tk 762-103-25	84	tk 775-4021-25	52	tk 775-4027-45 TSC	42
tk 708-680	79	tk 762-104	84	tk 775-4021-25 C	52	tk 775-4027-45 TSCM	42
tk 708-701	79	tk 762-104-25	84	tk 775-4021-25 CS	52	tk 775-4030	45
tk 708-702	79	tk 762-105	84	tk 775-4021-45	52	tk 775-4030 C	45
tk 708-703	79	tk 762-105-25	84	tk 775-4021-45 C	52	tk 775-4030 CS	45
tk 708-705 / LT 100	80	tk 770-110	27	tk 775-4021-45 CS	52	tk 775-4030-25	45
tk 708-706 / LT 200	80	tk 770-110-25	27	tk 775-4022	44	tk 775-4030-25 C	45
tk 708-707 / LT 300	80	tk 770-111	27	tk 775-4022	5	tk 775-4030-25 CS	45
tk 708-708 / LT 400	80	tk 770-111-25	27	tk 775-4022 C	44	tk 775-4030-45	45
tk 708-710	79	tk 775-3928	44	tk 775-4022-25	44	tk 775-4030-45 C	45
tk 708-711	79	tk 775-3928 C	44	tk 775-4022-25 C	44	tk 775-4030-45 CS	45
tk 708-712	79	tk 775-3928-25	44	tk 775-4022-45	44	tk 775-4031	45
tk 708-713	79	tk 775-3928-25 C	44	tk 775-4022-45 C	44	tk 775-4031 C	45
tk 708-741	80	tk 775-3928-45	44	tk 775-4023	44	tk 775-4031 CS	45
tk 708-742	80	tk 775-3928-45 C	44	tk 775-4023 C	44	tk 775-4031-25	45
tk 708-743	80	tk 775-3929	44	tk 775-4023-25	44	tk 775-4031-25 C	45
tk 708-750	80	tk 775-3929 C	44	tk 775-4023-25 C	44	tk 775-4031-25 CS	45
tk 708-751	80	tk 775-3929-25	44	tk 775-4023-45	44	tk 775-4031-45	45
tk 708-752	80	tk 775-3929-25 C	44	tk 775-4023-45 C	44	tk 775-4031-45 C	45
tk 708-753	80	tk 775-3929-45	44	tk 775-4024	44	tk 775-4031-45 CS	45
tk 708-761	80	tk 775-3929-45 C	44	tk 775-4024 C	44	tk 775-4032	45
tk 708-762	80	tk 775-3995	35	tk 775-4024-25	44	tk 775-4032 C	45
tk 708-763	80	tk 775-4000	36	tk 775-4024-25 C	44	tk 775-4032 CS	45
tk 708-770	80	tk 775-4001	36	tk 775-4024-45	44	tk 775-4032-25	45
tk 708-771	80	tk 775-4002	36	tk 775-4024-45 C	44	tk 775-4032-25 C	45
tk 708-772	80	tk 775-4003	35	tk 775-4025	44	tk 775-4032-25 CS	45

**Nummernverzeichnis**  
*Numerical Index*

**Index numérique**  
*Indice numerico*  
Indice dei numeri d'articolo

Art. No.	Page	Art. No.	Page	Art. No.	Page	Art. No.	Page
tk 775-4032-45	45	tk 775-4053 CS	51	tk 775-4067-45 C	48	tk 775-4074-25	49
tk 775-4032-45 C	45	tk 775-4053-25	51	tk 775-4067-45 CS	48	tk 775-4074-25 C	49
tk 775-4032-45 CS	45	tk 775-4053-25 C	51	tk 775-4068	49	tk 775-4074-25 CS	49
tk 775-4033	45	tk 775-4053-25 CS	51	tk 775-4068 C	49	tk 775-4074-45	49
tk 775-4033 C	45	tk 775-4053-45	51	tk 775-4068 CS	49	tk 775-4074-45 C	49
tk 775-4033 CS	45	tk 775-4053-45 C	51	tk 775-4068-25	49	tk 775-4074-45 CS	49
tk 775-4033-25	45	tk 775-4053-45 CS	51	tk 775-4068-25 C	49	tk 775-4075	52
tk 775-4033-25 C	45	tk 775-4062	46	tk 775-4068-25 CS	49	tk 775-4075 C	52
tk 775-4033-25 CS	45	tk 775-4062 C	46	tk 775-4068-45	49	tk 775-4075 CS	52
tk 775-4033-45	45	tk 775-4062 CS	46	tk 775-4068-45 C	49	tk 775-4075-25	52
tk 775-4033-45 C	45	tk 775-4062-25	46	tk 775-4068-45 CS	49	tk 775-4075-25 C	52
tk 775-4033-45 CS	45	tk 775-4062-25 C	46	tk 775-4069	52	tk 775-4075-25 CS	52
tk 775-4034	45	tk 775-4062-25 CS	46	tk 775-4069 C	52	tk 775-4075-45	52
tk 775-4034 C	45	tk 775-4062-45	46	tk 775-4069 CS	52	tk 775-4075-45 C	52
tk 775-4034 CS	45	tk 775-4062-45C	46	tk 775-4069-25	52	tk 775-4075-45 CS	52
tk 775-4034-25	45	tk 775-4062-45CS	46	tk 775-4069-25 C	52	tk 775-4076	49
tk 775-4034-25 C	45	tk 775-4063	48	tk 775-4069-25 CS	52	tk 775-4076 C	49
tk 775-4034-25 CS	45	tk 775-4063 C	48	tk 775-4069-45	52	tk 775-4076 CS	49
tk 775-4034-45	45	tk 775-4063 CS	48	tk 775-4069-45 C	52	tk 775-4076-25	49
tk 775-4034-45 C	45	tk 775-4063-25	48	tk 775-4069-45 CS	52	tk 775-4076-25 C	49
tk 775-4034-45 CS	45	tk 775-4063-25 C	48	tk 775-4070	54	tk 775-4076-25 CS	49
tk 775-4035	49	tk 775-4063-25 CS	48	tk 775-4070 C	54	tk 775-4076-45	49
tk 775-4035 C	49	tk 775-4063-45	48	tk 775-4070 CS	54	tk 775-4076-45 C	49
tk 775-4035 CS	49	tk 775-4063-45 C	48	tk 775-4070-25	54	tk 775-4076-45 CS	49
tk 775-4035-25	49	tk 775-4063-45 CS	48	tk 775-4070-25 C	54	tk 775-4078	51
tk 775-4035-25 C	49	tk 775-4064	52	tk 775-4070-25 CS	54	tk 775-4078 C	51
tk 775-4035-25 CS	49	tk 775-4064 C	52	tk 775-4070-45	54	tk 775-4078 CS	51
tk 775-4035-45	49	tk 775-4064 CS	52	tk 775-4070-45 C	54	tk 775-4078-25	51
tk 775-4035-45 C	49	tk 775-4064-25	52	tk 775-4070-45 CS	54	tk 775-4078-25 C	51
tk 775-4035-45 CS	49	tk 775-4064-25 C	52	tk 775-4071	54	tk 775-4078-25 CS	51
tk 775-4036	48	tk 775-4064-25 CS	52	tk 775-4071 C	54	tk 775-4078-45	51
tk 775-4036 C	48	tk 775-4064-45	52	tk 775-4071 CS	54	tk 775-4078-45 C	51
tk 775-4036 CS	48	tk 775-4064-45 C	52	tk 775-4071-25	54	tk 775-4078-45 CS	51
tk 775-4036-25	48	tk 775-4064-45 CS	52	tk 775-4071-25 C	54	tk 775-4079	49
tk 775-4036-25 C	48	tk 775-4065	51	tk 775-4071-25 CS	54	tk 775-4079 C	49
tk 775-4036-25 CS	48	tk 775-4065 C	51	tk 775-4071-45	54	tk 775-4079 CS	49
tk 775-4036-45	48	tk 775-4065 CS	51	tk 775-4071-45 C	54	tk 775-4079-25	49
tk 775-4036-45 C	48	tk 775-4065-25	51	tk 775-4071-45 CS	54	tk 775-4079-25 C	49
tk 775-4036-45 CS	48	tk 775-4065-25 C	51	tk 775-4072	51	tk 775-4079-25 CS	49
tk 775-4037	48	tk 775-4065-25 CS	51	tk 775-4072 C	51	tk 775-4079-45	49
tk 775-4037 C	48	tk 775-4065-45	51	tk 775-4072 CS	51	tk 775-4079-45 C	49
tk 775-4037 CS	48	tk 775-4065-45 C	51	tk 775-4072-25	51	tk 775-4079-45 CS	49
tk 775-4037-25	48	tk 775-4065-45 CS	51	tk 775-4072-25 C	51	tk 775-4080	48
tk 775-4037-25 C	48	tk 775-4066	45	tk 775-4072-25 CS	51	tk 775-4080 C	48
tk 775-4037-25 CS	48	tk 775-4066 C	45	tk 775-4072-45	51	tk 775-4080 CS	48
tk 775-4037-45	48	tk 775-4066 CS	45	tk 775-4072-45 C	51	tk 775-4080-25	48
tk 775-4037-45 C	48	tk 775-4066-25	45	tk 775-4072-45 CS	51	tk 775-4080-25 C	48
tk 775-4037-45 CS	48	tk 775-4066-25 C	45	tk 775-4073	51	tk 775-4080-25 CS	48
tk 775-4038	48	tk 775-4066-25 CS	45	tk 775-4073 C	51	tk 775-4080-45	48
tk 775-4038 C	48	tk 775-4066-45	45	tk 775-4073 CS	51	tk 775-4080-45 C	48
tk 775-4038 CS	48	tk 775-4066-45 C	45	tk 775-4073-25	51	tk 775-4080-45 CS	48
tk 775-4038-25	48	tk 775-4066-45 CS	45	tk 775-4073-25 C	51	tk 775-4081	49
tk 775-4038-25 C	48	tk 775-4067	48	tk 775-4073-25 CS	51	tk 775-4081 C	49
tk 775-4038-25 CS	48	tk 775-4067 C	48	tk 775-4073-45	51	tk 775-4081 CS	49
tk 775-4038-45	48	tk 775-4067 CS	48	tk 775-4073-45 C	51	tk 775-4081-25	49
tk 775-4038-45 C	48	tk 775-4067-25	48	tk 775-4073-45 CS	51	tk 775-4081-25 C	49
tk 775-4038-45 CS	48	tk 775-4067-25 C	48	tk 775-4074	49	tk 775-4081-25 CS	49
tk 775-4053	51	tk 775-4067-25 CS	48	tk 775-4074 C	49	tk 775-4081-45	49
tk 775-4053 C	51	tk 775-4067-45	48	tk 775-4074 CS	49	tk 775-4081-45 C	49

Nummernverzeichnis  
*Numerical Index*

Index numérique  
*Indice numerico*  
Indice dei numeri d'articolo

Art. No.	Page	Art. No.	Page	Art. No.	Page	Art. No.	Page
tk 775-4081-45 CS	49	tk 775-4088-25 C	52	tk 775-4095	48	tk 775-4101-25 CS	50
tk 775-4082	47	tk 775-4088-25 CS	52	tk 775-4095 C	48	tk 775-4101-45	50
tk 775-4082 C	47	tk 775-4088-45	52	tk 775-4095 CS	48	tk 775-4101-45 C	50
tk 775-4082 CS	47	tk 775-4088-45 C	52	tk 775-4095-25	48	tk 775-4101-45 CS	50
tk 775-4082-25	47	tk 775-4088-45 CS	52	tk 775-4095-25 C	48	tk 775-4110	37
tk 775-4082-25 C	47	tk 775-4089	51	tk 775-4095-25 CS	48	tk 775-4111	37
tk 775-4082-25 CS	47	tk 775-4089 C	51	tk 775-4095-45	48	tk 775-4112	37
tk 775-4082-45	47	tk 775-4089 CS	51	tk 775-4095-45 C	48	tk 775-4113	37
tk 775-4082-45 C	47	tk 775-4089-25	51	tk 775-4095-45 CS	48	tk 775-4114	37
tk 775-4082-45 CS	47	tk 775-4089-25 C	51	tk 775-4096	46	tk 775-4114-25	37
tk 775-4083	46	tk 775-4089-25 CS	51	tk 775-4096 C	46	tk 775-4114-45	37
tk 775-4083 C	46	tk 775-4089-45	51	tk 775-4096 CS	46	tk 775-4119	47
tk 775-4083 CS	46	tk 775-4089-45 C	51	tk 775-4096-25	46	tk 775-4119 C	47
tk 775-4083-25	46	tk 775-4089-45 CS	51	tk 775-4096-25 C	46	tk 775-4119 CS	47
tk 775-4083-25 C	46	tk 775-4090	49	tk 775-4096-25 CS	46	tk 775-4119-25	47
tk 775-4083-25 CS	46	tk 775-4090 C	49	tk 775-4096-45	46	tk 775-4119-25 C	47
tk 775-4083-45	46	tk 775-4090 CS	49	tk 775-4096-45 C	46	tk 775-4119-25 CS	47
tk 775-4083-45 C	46	tk 775-4090-25	49	tk 775-4096-45 CS	46	tk 775-4119-45	47
tk 775-4083-45 CS	46	tk 775-4090-25 C	49	tk 775-4097	46	tk 775-4119-45 C	47
tk 775-4084	46	tk 775-4090-25 CS	49	tk 775-4097 C	46	tk 775-4119-45 CS	47
tk 775-4084 C	46	tk 775-4090-45	49	tk 775-4097 CS	46	tk 775-4120	47
tk 775-4084 CS	46	tk 775-4090-45 C	49	tk 775-4097-25	46	tk 775-4120 C	47
tk 775-4084-25	46	tk 775-4090-45 CS	49	tk 775-4097-25 C	46	tk 775-4120 CS	47
tk 775-4084-25 C	46	tk 775-4091	50	tk 775-4097-25 CS	46	tk 775-4120-25	47
tk 775-4084-25 CS	46	tk 775-4091 C	50	tk 775-4097-45	46	tk 775-4120-25 C	47
tk 775-4084-45	46	tk 775-4091 CS	50	tk 775-4097-45 C	46	tk 775-4120-25 CS	47
tk 775-4084-45 C	46	tk 775-4091-25	50	tk 775-4097-45 CS	46	tk 775-4120-45	47
tk 775-4084-45 CS	46	tk 775-4091-25 C	50	tk 775-4098	53	tk 775-4120-45 C	47
tk 775-4085	46	tk 775-4091-25 CS	50	tk 775-4098 C	53	tk 775-4120-45 CS	47
tk 775-4085 C	46	tk 775-4091-45	50	tk 775-4098 CS	53	tk 775-4121	47
tk 775-4085 CS	46	tk 775-4091-45 C	50	tk 775-4098-25	53	tk 775-4121 C	47
tk 775-4085-25	46	tk 775-4091-45 CS	50	tk 775-4098-25 C	53	tk 775-4121 CS	47
tk 775-4085-25 C	46	tk 775-4092	53	tk 775-4098-25 CS	53	tk 775-4121-25	47
tk 775-4085-25 CS	46	tk 775-4092 C	53	tk 775-4098-45	53	tk 775-4121-25 C	47
tk 775-4085-45	46	tk 775-4092 CS	53	tk 775-4098-45 C	53	tk 775-4121-25 CS	47
tk 775-4085-45 C	46	tk 775-4092-25	53	tk 775-4098-45 CS	53	tk 775-4121-45	47
tk 775-4085-45 CS	46	tk 775-4092-25 C	53	tk 775-4099	50	tk 775-4121-45 C	47
tk 775-4086	46	tk 775-4092-25 CS	53	tk 775-4099 C	50	tk 775-4121-45 CS	47
tk 775-4086 C	46	tk 775-4092-45	53	tk 775-4099 CS	50	tk 775-4210 TS	43
tk 775-4086 CS	46	tk 775-4092-45 C	53	tk 775-4099-25	50	tk 775-4210 TSC	43
tk 775-4086-25	46	tk 775-4092-45 CS	53	tk 775-4099-25 C	50	tk 775-4210 TSCS	43
tk 775-4086-25 C	46	tk 775-4093	47	tk 775-4099-25 CS	50	tk 775-4210-25 TS	43
tk 775-4086-25 CS	46	tk 775-4093 C	47	tk 775-4099-45	50	tk 775-4210-25 TSC	43
tk 775-4086-45	46	tk 775-4093 CS	47	tk 775-4099-45 C	50	tk 775-4210-25 TSCS	43
tk 775-4086-45 C	46	tk 775-4093-25	47	tk 775-4099-45 CS	50	tk 775-4210-45 TS	43
tk 775-4086-45 CS	46	tk 775-4093-25 C	47	tk 775-4100	50	tk 775-4210-45 TSC	43
tk 775-4087	46	tk 775-4093-25 CS	47	tk 775-4100 C	50	tk 775-4210-45 TSCS	43
tk 775-4087 C	46	tk 775-4093-45	47	tk 775-4100 CS	50	tk 775-4212 TS	43
tk 775-4087 CS	46	tk 775-4093-45 C	47	tk 775-4100-25	50	tk 775-4212 TSC	43
tk 775-4087-25	46	tk 775-4093-45 CS	47	tk 775-4100-25 C	50	tk 775-4212 TSCS	43
tk 775-4087-25 C	46	tk 775-4094	48	tk 775-4100-25 CS	50	tk 775-4212-25 TS	43
tk 775-4087-25 CS	46	tk 775-4094 C	48	tk 775-4100-45	50	tk 775-4212-25 TSC	43
tk 775-4087-45	46	tk 775-4094 CS	48	tk 775-4100-45 C	50	tk 775-4212-25 TSCS	43
tk 775-4087-45 C	46	tk 775-4094-25	48	tk 775-4100-45 CS	50	tk 775-4212-45 TS	43
tk 775-4087-45 CS	46	tk 775-4094-25 C	48	tk 775-4101	50	tk 775-4212-45 TSC	43
tk 775-4088	52	tk 775-4094-25 CS	48	tk 775-4101 C	50	tk 775-4212-45 TSCS	43
tk 775-4088 C	52	tk 775-4094-45	48	tk 775-4101 CS	50	tk 775-4213 TS	43
tk 775-4088 CS	52	tk 775-4094-45 C	48	tk 775-4101-25	50	tk 775-4213 TSC	43
tk 775-4088-25	52	tk 775-4094-45 CS	48	tk 775-4101-25 C	50	tk 775-4213 TSCS	43



**Nummernverzeichnis**  
*Numerical Index*

**Index numérique**  
*Indice numerico*  
Indice dei numeri d'articolo

Art. No.	Page	Art. No.	Page	Art. No.	Page	Art. No.	Page
tk 775-4213-25 TS	43	tk 775-4228-45 CS	52	tk 775-4243-25 C	47	tk 775-5021-45 C	62
tk 775-4213-25 TSC	43	tk 775-4229	53	tk 775-4243-25 CS	47	tk 775-5021-45 CS	62
tk 775-4213-25 TSCS	43	tk 775-4229 C	53	tk 775-4243-45	47	tk 775-5022	62
tk 775-4213-45 TS	43	tk 775-4229 CS	53	tk 775-4243-45 C	47	tk 775-5022 C	62
tk 775-4213-45 TSC	43	tk 775-4229-25	53	tk 775-4243-45 CS	47	tk 775-5022 CS	62
tk 775-4213-45 TSCS	43	tk 775-4229-25 C	53	tk 775-4244	51	tk 775-5022-25	62
tk 775-4214 TS	43	tk 775-4229-25 CS	53	tk 775-4244 C	51	tk 775-5022-25 C	62
tk 775-4214 TSC	43	tk 775-4229-45	53	tk 775-4244 CS	51	tk 775-5022-25 CS	62
tk 775-4214 TSCS	43	tk 775-4229-45 C	53	tk 775-4244-25	51	tk 775-5022-45	62
tk 775-4214-25 TS	43	tk 775-4229-45 CS	53	tk 775-4244-25 C	51	tk 775-5022-45 C	62
tk 775-4214-25 TSC	43	tk 775-4232	50	tk 775-4244-25 CS	51	tk 775-5022-45 CS	62
tk 775-4214-25 TSCS	43	tk 775-4232 C	50	tk 775-4244-45	51	tk 775-5023	63
tk 775-4214-45 TS	43	tk 775-4232 CS	50	tk 775-4244-45 C	51	tk 775-5023 C	63
tk 775-4214-45 TSC	43	tk 775-4232-25	50	tk 775-4244-45 CS	51	tk 775-5023 CS	63
tk 775-4214-45 TSCS	43	tk 775-4232-25 C	50	tk 775-4245	45	tk 775-5023-25	63
tk 775-4222	52	tk 775-4232-25 CS	50	tk 775-4245 C	45	tk 775-5023-25 C	63
tk 775-4222 C	52	tk 775-4232-45	50	tk 775-4245 CS	45	tk 775-5023-25 CS	63
tk 775-4222 CS	52	tk 775-4232-45 C	50	tk 775-4245-25	45	tk 775-5023-45	63
tk 775-4222-25	52	tk 775-4232-45 CS	50	tk 775-4245-25 C	45	tk 775-5023-45 C	63
tk 775-4222-25 C	52	tk 775-4233	53	tk 775-4245-25 CS	45	tk 775-5023-45 CS	63
tk 775-4222-25 CS	52	tk 775-4233 C	53	tk 775-4245-45	45	tk 775-5024	63
tk 775-4222-45	52	tk 775-4233 CS	53	tk 775-4245-45 C	45	tk 775-5024 C	63
tk 775-4222-45 C	52	tk 775-4233-25	53	tk 775-4245-45 CS	45	tk 775-5024 CS	63
tk 775-4222-45 CS	52	tk 775-4233-25 C	53	tk 775-4246	53	tk 775-5024-25	63
tk 775-4224	53	tk 775-4233-25 CS	53	tk 775-4246 C	53	tk 775-5024-25 C	63
tk 775-4224 C	53	tk 775-4233-45	53	tk 775-4246 CS	53	tk 775-5024-25 CS	63
tk 775-4224 CS	53	tk 775-4233-45 C	53	tk 775-4246-25	53	tk 775-5024-45	63
tk 775-4224-25	53	tk 775-4233-45 CS	53	tk 775-4246-25 C	53	tk 775-5024-45 C	63
tk 775-4224-25 C	53	tk 775-4234	53	tk 775-4246-25 CS	53	tk 775-5024-45 CS	63
tk 775-4224-25 CS	53	tk 775-4234 C	53	tk 775-4246-45	53	tk 775-5025	59
tk 775-4224-45	53	tk 775-4234 CS	53	tk 775-4246-45 C	53	tk 775-5025 C	59
tk 775-4224-45 C	53	tk 775-4234-25	53	tk 775-4246-45 CS	53	tk 775-5025 CS	59
tk 775-4224-45 CS	53	tk 775-4234-25 C	53	tk 775-4249	50	tk 775-5025-25	59
tk 775-4225	49	tk 775-4234-25 CS	53	tk 775-4249 C	50	tk 775-5025-25 C	59
tk 775-4225 C	49	tk 775-4234-45	53	tk 775-4249 CS	50	tk 775-5025-25 CS	59
tk 775-4225 CS	49	tk 775-4234-45 C	53	tk 775-4249-25	50	tk 775-5025-45	59
tk 775-4225-25	49	tk 775-4234-45 CS	53	tk 775-4249-25 C	50	tk 775-5025-45 C	59
tk 775-4225-25 C	49	tk 775-4235	50	tk 775-4249-25 CS	50	tk 775-5025-45 CS	59
tk 775-4225-25 CS	49	tk 775-4235 C	50	tk 775-4249-45	50	tk 775-5026	64
tk 775-4225-45	49	tk 775-4235 CS	50	tk 775-4249-45 C	50	tk 775-5026 C	64
tk 775-4225-45 C	49	tk 775-4235-25	50	tk 775-4249-45 CS	50	tk 775-5026 CS	64
tk 775-4225-45 CS	49	tk 775-4235-25 C	50	tk 775-4253	54	tk 775-5026-25	64
tk 775-4226	54	tk 775-4235-25 CS	50	tk 775-4253 C	54	tk 775-5026-25 C	64
tk 775-4226 C	54	tk 775-4235-45	50	tk 775-4253 CS	54	tk 775-5026-25 CS	64
tk 775-4226 CS	54	tk 775-4235-45 C	50	tk 775-4253-25	54	tk 775-5026-45	64
tk 775-4226-25	54	tk 775-4235-45 CS	50	tk 775-4253-25 C	54	tk 775-5026-45 C	64
tk 775-4226-25 C	54	tk 775-4236	50	tk 775-4253-25 CS	54	tk 775-5026-45 CS	64
tk 775-4226-25 CS	54	tk 775-4236 C	50	tk 775-4253-45	54	tk 775-5027	62
tk 775-4226-45	54	tk 775-4236 CS	50	tk 775-4253-45 C	54	tk 775-5027 C	62
tk 775-4226-45 C	54	tk 775-4236-25	50	tk 775-4253-45 CS	54	tk 775-5027 CS	62
tk 775-4226-45 CS	54	tk 775-4236-25 C	50	tk 775-4303	36	tk 775-5027-25	62
tk 775-4228	52	tk 775-4236-25 CS	50	tk 775-4304	36	tk 775-5027-25 C	62
tk 775-4228 C	52	tk 775-4236-45	50	tk 775-5021	62	tk 775-5027-25 CS	62
tk 775-4228 CS	52	tk 775-4236-45 C	50	tk 775-5021 C	62	tk 775-5027-45	62
tk 775-4228-25	52	tk 775-4236-45 CS	50	tk 775-5021 CS	62	tk 775-5027-45 C	62
tk 775-4228-25 C	52	tk 775-4243	47	tk 775-5021-25	62	tk 775-5027-45 CS	62
tk 775-4228-25 CS	52	tk 775-4243 C	47	tk 775-5021-25 C	62	tk 775-5028	62
tk 775-4228-45	52	tk 775-4243 CS	47	tk 775-5021-25 CS	62	tk 775-5028 C	62
tk 775-4228-45 C	52	tk 775-4243-25	47	tk 775-5021-45	62	tk 775-5028 CS	62

Nummernverzeichnis  
*Numerical Index*

Index numérique  
*Indice numerico*  
Indice dei numeri d'articolo

Art. No.	Page	Art. No.	Page	Art. No.	Page	Art. No.	Page
tk 775-5028-25	62	tk 775-5038-45 CS	64	tk 775-5048-25 C	60	tk 775-5056	58
tk 775-5028-25 C	62	tk 775-5041	64	tk 775-5048-25 CS	60	tk 775-5056 C	58
tk 775-5028-25 CS	62	tk 775-5041 C	64	tk 775-5048-45	60	tk 775-5056 CS	58
tk 775-5028-45	62	tk 775-5041 CS	64	tk 775-5048-45 C	60	tk 775-5056-25	58
tk 775-5028-45 C	62	tk 775-5041-25	64	tk 775-5048-45 CS	60	tk 775-5056-25 C	58
tk 775-5028-45 CS	62	tk 775-5041-25 C	64	tk 775-5049	60	tk 775-5056-25 CS	58
tk 775-5029	63	tk 775-5041-25 CS	64	tk 775-5049 C	60	tk 775-5056-45	58
tk 775-5029 C	63	tk 775-5041-45	64	tk 775-5049 CS	60	tk 775-5056-45 C	58
tk 775-5029 CS	63	tk 775-5041-45 C	64	tk 775-5049-25	60	tk 775-5056-45 CS	58
tk 775-5029-25	63	tk 775-5041-45 CS	64	tk 775-5049-25 C	60	tk 775-5058	58
tk 775-5029-25 C	63	tk 775-5043	57	tk 775-5049-25 CS	60	tk 775-5058 C	58
tk 775-5029-25 CS	63	tk 775-5043 C	57	tk 775-5049-45	60	tk 775-5058 CS	58
tk 775-5029-45	63	tk 775-5043 CS	57	tk 775-5049-45 C	60	tk 775-5058-25	58
tk 775-5029-45 C	63	tk 775-5043-25	57	tk 775-5049-45 CS	60	tk 775-5058-25 C	58
tk 775-5029-45 CS	63	tk 775-5043-25 C	57	tk 775-5050	55	tk 775-5058-25 CS	58
tk 775-5032	60	tk 775-5043-25 CS	57	tk 775-5050 C	55	tk 775-5058-45	58
tk 775-5032 C	60	tk 775-5043-45	57	tk 775-5050 CS	55	tk 775-5058-45 C	58
tk 775-5032 CS	60	tk 775-5043-45 C	57	tk 775-5050-25	55	tk 775-5058-45 CS	58
tk 775-5032-25	60	tk 775-5043-45 CS	57	tk 775-5050-25 C	55	tk 775-5064	62
tk 775-5032-25 C	60	tk 775-5044	63	tk 775-5050-25 CS	55	tk 775-5064 C	62
tk 775-5032-25 CS	60	tk 775-5044 C	63	tk 775-5050-45	55	tk 775-5064 CS	62
tk 775-5032-45	60	tk 775-5044 CS	63	tk 775-5050-45 C	55	tk 775-5064-25	62
tk 775-5032-45 C	60	tk 775-5044-25	63	tk 775-5050-45 CS	55	tk 775-5064-25 C	62
tk 775-5032-45 CS	60	tk 775-5044-25 C	63	tk 775-5052	55	tk 775-5064-25 CS	62
tk 775-5034	63	tk 775-5044-25 CS	63	tk 775-5052 C	55	tk 775-5064-45	62
tk 775-5034 C	63	tk 775-5044-45	63	tk 775-5052 CS	55	tk 775-5064-45 C	62
tk 775-5034 CS	63	tk 775-5044-45 C	63	tk 775-5052-25	55	tk 775-5064-45 CS	62
tk 775-5034-25	63	tk 775-5044-45 CS	63	tk 775-5052-25 C	55	tk 775-5065	61
tk 775-5034-25 C	63	tk 775-5045	55	tk 775-5052-25 CS	55	tk 775-5065 C	61
tk 775-5034-25 CS	63	tk 775-5045 C	55	tk 775-5052-45	55	tk 775-5065 CS	61
tk 775-5034-45	63	tk 775-5045 CS	55	tk 775-5052-45 C	55	tk 775-5065-25	61
tk 775-5034-45 C	63	tk 775-5045-25	55	tk 775-5052-45 CS	55	tk 775-5065-25 C	61
tk 775-5034-45 CS	63	tk 775-5045-25 C	55	tk 775-5053	55	tk 775-5065-25 CS	61
tk 775-5035	60	tk 775-5045-25 CS	55	tk 775-5053 C	55	tk 775-5065-45	61
tk 775-5035 C	60	tk 775-5045-45	55	tk 775-5053 CS	55	tk 775-5065-45 C	61
tk 775-5035 CS	60	tk 775-5045-45 C	55	tk 775-5053-25	55	tk 775-5065-45 CS	61
tk 775-5035-25	60	tk 775-5045-45 CS	55	tk 775-5053-25 C	55	tk 775-5066	55
tk 775-5035-25 C	60	tk 775-5046	63	tk 775-5053-25 CS	55	tk 775-5066 C	55
tk 775-5035-25 CS	60	tk 775-5046 C	63	tk 775-5053-45	55	tk 775-5066 CS	55
tk 775-5035-45	60	tk 775-5046 CS	63	tk 775-5053-45 C	55	tk 775-5066-25	55
tk 775-5035-45 C	60	tk 775-5046-25	63	tk 775-5053-45 CS	55	tk 775-5066-25 C	55
tk 775-5035-45 CS	60	tk 775-5046-25 C	63	tk 775-5054	55	tk 775-5066-25 CS	55
tk 775-5036	60	tk 775-5046-25 CS	63	tk 775-5054 C	55	tk 775-5066-45	55
tk 775-5036 C	60	tk 775-5046-45	63	tk 775-5054 CS	55	tk 775-5066-45 C	55
tk 775-5036 CS	60	tk 775-5046-45 C	63	tk 775-5054-25	55	tk 775-5066-45 CS	55
tk 775-5036-25	60	tk 775-5046-45 CS	63	tk 775-5054-25 C	55	tk 775-5067	58
tk 775-5036-25 C	60	tk 775-5047	60	tk 775-5054-25 CS	55	tk 775-5067 C	58
tk 775-5036-25 CS	60	tk 775-5047 C	60	tk 775-5054-45	55	tk 775-5067 CS	58
tk 775-5036-45	60	tk 775-5047 CS	60	tk 775-5054-45 C	55	tk 775-5067-25	58
tk 775-5036-45 C	60	tk 775-5047-25	60	tk 775-5054-45 CS	55	tk 775-5067-25 C	58
tk 775-5036-45 CS	60	tk 775-5047-25 C	60	tk 775-5055	59	tk 775-5067-25 CS	58
tk 775-5038	64	tk 775-5047-25 CS	60	tk 775-5055 C	59	tk 775-5067-45	58
tk 775-5038 C	64	tk 775-5047-45	60	tk 775-5055 CS	59	tk 775-5067-45 C	58
tk 775-5038 CS	64	tk 775-5047-45 C	60	tk 775-5055-25	59	tk 775-5067-45 CS	58
tk 775-5038-25	64	tk 775-5047-45 CS	60	tk 775-5055-25 C	59	tk 775-5068	59
tk 775-5038-25 C	64	tk 775-5048	60	tk 775-5055-25 CS	59	tk 775-5068 C	59
tk 775-5038-25 CS	64	tk 775-5048 C	60	tk 775-5055-45	59	tk 775-5068 CS	59
tk 775-5038-45	64	tk 775-5048 CS	60	tk 775-5055-45 C	59	tk 775-5068-25	59
tk 775-5038-45 C	64	tk 775-5048-25	60	tk 775-5055-45 CS	59	tk 775-5068-25 C	59



**Nummernverzeichnis**  
*Numerical Index*

**Index numérique**  
*Indice numerico*  
Indice dei numeri d'articolo

Art. No.	Page	Art. No.	Page	Art. No.	Page	Art. No.	Page
tk 775-5068-25 CS	59	tk 775-5081 C	59	tk 775-5090-45	59	tk 783-102-45	39
tk 775-5068-45	59	tk 775-5081 CS	59	tk 775-5090-45 C	59	tk 783-104	39
tk 775-5068-45 C	59	tk 775-5081-25	59	tk 775-5090-45 CS	59	tk 783-104-25	39
tk 775-5068-45 CS	59	tk 775-5081-25 C	59	tk 775-5093	57	tk 783-104-45	39
tk 775-5069	62	tk 775-5081-25 CS	59	tk 775-5093 C	57	tk 783-106	39
tk 775-5069 C	62	tk 775-5081-45	59	tk 775-5093 CS	57	tk 783-106-25	39
tk 775-5069 CS	62	tk 775-5081-45 C	59	tk 775-5093-25	57	tk 783-106-45	39
tk 775-5069-25	62	tk 775-5081-45 CS	59	tk 775-5093-25 C	57	tk 783-107	39
tk 775-5069-25 C	62	tk 775-5083	56	tk 775-5093-25 CS	57	tk 783-107-25	39
tk 775-5069-25 CS	62	tk 775-5083 C	56	tk 775-5093-45	57	tk 783-107-45	39
tk 775-5069-45	62	tk 775-5083 CS	56	tk 775-5093-45 C	57	tk 783-120	39
tk 775-5069-45 C	62	tk 775-5083-25	56	tk 775-5093-45 CS	57	tk 783-120-25	39
tk 775-5069-45 CS	62	tk 775-5083-25 C	56	tk 775-5094	58	tk 783-120-45	39
tk 775-5073	61	tk 775-5083-25 CS	56	tk 775-5094 C	58	tk 783-123	39
tk 775-5073 C	61	tk 775-5083-45	56	tk 775-5094 CS	58	tk 783-123-25	39
tk 775-5073 CS	61	tk 775-5083-45 C	56	tk 775-5094-25	58	tk 783-123-45	39
tk 775-5073-25	61	tk 775-5083-45 CS	56	tk 775-5094-25 C	58	tk 783-124	39
tk 775-5073-25 C	61	tk 775-5084	56	tk 775-5094-25 CS	58	tk 783-124-25	39
tk 775-5073-25 CS	61	tk 775-5084 C	56	tk 775-5094-45	58	tk 783-124-45	39
tk 775-5073-45	61	tk 775-5084 CS	56	tk 775-5094-45 C	58	tk 783-125	39
tk 775-5073-45 C	61	tk 775-5084-25	56	tk 775-5094-45 CS	58	tk 783-125-25	39
tk 775-5073-45 CS	61	tk 775-5084-25 C	56	tk 775-5096	56	tk 783-125-45	39
tk 775-5074	59	tk 775-5084-25 CS	56	tk 775-5096 C	56	tk 783-127	40
tk 775-5074 C	59	tk 775-5084-45	56	tk 775-5096 CS	56	tk 783-127-25	40
tk 775-5074 CS	59	tk 775-5084-45 C	56	tk 775-5096-25	56	tk 783-127-45	40
tk 775-5074-25	59	tk 775-5084-45 CS	56	tk 775-5096-25 C	56	tk 783-128	39
tk 775-5074-25 C	59	tk 775-5087	56	tk 775-5096-25 CS	56	tk 783-128-25	39
tk 775-5074-25 CS	59	tk 775-5087 C	56	tk 775-5096-45	56	tk 783-128-45	39
tk 775-5074-45	59	tk 775-5087 CS	56	tk 775-5096-45 C	56	tk 783-129	41
tk 775-5074-45 C	59	tk 775-5087-25	56	tk 775-5096-45 CS	56	tk 783-129-25	41
tk 775-5074-45 CS	59	tk 775-5087-25 C	56	tk 775-5097	56	tk 783-129-45	41
tk 775-5076	59	tk 775-5087-25 CS	56	tk 775-5097 C	56	tk 783-130	41
tk 775-5076 C	59	tk 775-5087-45	56	tk 775-5097 CS	56	tk 783-130-25	41
tk 775-5076 CS	59	tk 775-5087-45 C	56	tk 775-5097-25	56	tk 783-130-45	41
tk 775-5076-25	59	tk 775-5087-45 CS	56	tk 775-5097-25 C	56	tk 783-132	41
tk 775-5076-25 C	59	tk 775-5088	62	tk 775-5097-25 CS	56	tk 783-132-25	41
tk 775-5076-25 CS	59	tk 775-5088 C	62	tk 775-5097-45	56	tk 783-132-45	41
tk 775-5076-45	59	tk 775-5088 CS	62	tk 775-5097-45 C	56	tk 783-141	41
tk 775-5076-45 C	59	tk 775-5088-25	62	tk 775-5097-45 CS	56	tk 783-141-25	41
tk 775-5076-45 CS	59	tk 775-5088-25 C	62	tk 775-5099	60	tk 783-141-45	41
tk 775-5078	61	tk 775-5088-25 CS	62	tk 775-5099 C	60	tk 783-142	41
tk 775-5078 C	61	tk 775-5088-45	62	tk 775-5099 CS	60	tk 783-142-25	41
tk 775-5078 CS	61	tk 775-5088-45 C	62	tk 775-5099-25	60	tk 783-142-45	41
tk 775-5078-25	61	tk 775-5088-45 CS	62	tk 775-5099-25 C	60	tk 783-143	41
tk 775-5078-25 C	61	tk 775-5089	61	tk 775-5099-25 CS	60	tk 783-143-25	41
tk 775-5078-25 CS	61	tk 775-5089 C	61	tk 775-5099-45	60	tk 783-143-45	41
tk 775-5078-45	61	tk 775-5089 CS	61	tk 775-5099-45 C	60	tk 783-145	40
tk 775-5078-45 C	61	tk 775-5089-25	61	tk 775-5099-45 CS	60	tk 783-145-25	40
tk 775-5078-45 CS	61	tk 775-5089-25 C	61	tk 775-5253	64	tk 783-145-45	40
tk 775-5079	59	tk 775-5089-25 CS	61	tk 775-5253 C	64	tk 783-150	41
tk 775-5079 C	59	tk 775-5089-45	61	tk 775-5253 CS	64	tk 783-150-25	41
tk 775-5079 CS	59	tk 775-5089-45 C	61	tk 775-5253-25	64	tk 783-150-45	41
tk 775-5079-25	59	tk 775-5089-45 CS	61	tk 775-5253-25 C	64	tk 783-151	40
tk 775-5079-25 C	59	tk 775-5090	59	tk 775-5253-25 CS	64	tk 783-151-25	40
tk 775-5079-25 CS	59	tk 775-5090 C	59	tk 775-5253-45	64	tk 783-151-45	40
tk 775-5079-45	59	tk 775-5090 CS	59	tk 775-5253-45 C	64	tk 783-152	40
tk 775-5079-45 C	59	tk 775-5090-25	59	tk 775-5253-45 CS	64	tk 783-152-25	40
tk 775-5079-45 CS	59	tk 775-5090-25 C	59	tk 783-102	39	tk 783-152-45	40
tk 775-5081	59	tk 775-5090-25 CS	59	tk 783-102-25	39	tk 783-154	40

Nummernverzeichnis  
*Numerical Index*

Index numérique  
*Indice numerico*  
Indice dei numeri d'articolo

Art. No.	Page	Art. No.	Page	Art. No.	Page	Art. No.	Page
tk 783-154-25	40	tk 783-254	40	tk 783-641-45	41	tk 791-176	91
tk 783-154-45	40	tk 783-254-25	40	tk 783-642	41	tk 791-180	89
tk 783-155	40	tk 783-254-45	40	tk 783-642-25	41	tk 791-185	89
tk 783-155-25	40	tk 783-255	40	tk 783-642-45	41	tk 791-187	89
tk 783-155-45	40	tk 783-255-25	40	tk 783-643	41	tk 791-189	89
tk 783-156	41	tk 783-255-45	40	tk 783-643-25	41	tk 795-4910	32
tk 783-156-25	41	tk 783-256	41	tk 783-643-45	41	tk 87015-20	92
tk 783-156-45	41	tk 783-256-25	41	tk 783-645	40	tk 87200-1F-SI	92
tk 783-157	40	tk 783-256-45	41	tk 783-645-25	40	tk 87280-2F-BK	93
tk 783-157-25	40	tk 783-257	40	tk 783-645-45	40	tk 87280-2F-BL	93
tk 783-157-45	40	tk 783-257-25	40	tk 783-650	41	tk 87280-2F-GR	93
tk 783-158	40	tk 783-257-45	40	tk 783-650-25	41	tk 87280-2F-RE	93
tk 783-158-25	40	tk 783-258	40	tk 783-650-45	41	tk 87280-2F-SI	93
tk 783-158-45	40	tk 783-258-25	40	tk 783-651	40	tk 87280-2F-YE	93
tk 783-159	40	tk 783-258-45	40	tk 783-651-25	40	tk 87290-2F-BK	93
tk 783-159-25	40	tk 783-259	40	tk 783-651-45	40	tk 87290-2F-BL	93
tk 783-159-45	40	tk 783-259-25	40	tk 783-652	40	tk 87290-2F-GR	93
tk 783-202	39	tk 783-259-45	40	tk 783-652-25	40	tk 87290-2F-RE	93
tk 783-202-25	39	tk 783-602	39	tk 783-652-45	40	tk 87290-2F-SI	93
tk 783-202-45	39	tk 783-602-25	39	tk 783-654	40	tk 87290-2F-YE	93
tk 783-204	39	tk 783-602-45	39	tk 783-654-25	40	tk 87295-00	92
tk 783-204-25	39	tk 783-604	39	tk 783-654-45	40	tk 95000-00	94
tk 783-204-45	39	tk 783-604-25	39	tk 783-655	40	tk 95000-50	94
tk 783-206	39	tk 783-604-45	39	tk 783-655-25	40	tk 95000-51	94
tk 783-206-25	39	tk 783-606	39	tk 783-655-45	40	tk 95000-52	94
tk 783-206-45	39	tk 783-606-25	39	tk 783-656	41	tk 95010-00	94
tk 783-207	39	tk 783-606-45	39	tk 783-656-25	41	tk 95011-00	94
tk 783-207-25	39	tk 783-607	39	tk 783-656-45	41	tk 95011-02	94
tk 783-207-45	39	tk 783-607-25	39	tk 783-657	40	tk 95012-00	94
tk 783-225	39	tk 783-607-45	39	tk 783-657-25	40	tk 95100-00	94
tk 783-225-25	39	tk 783-620	39	tk 783-657-45	40		
tk 783-225-45	39	tk 783-620-25	39	tk 783-658	40		
tk 783-227	40	tk 783-620-45	39	tk 783-658-25	40		
tk 783-227-25	40	tk 783-623	39	tk 783-658-45	40		
tk 783-227-45	40	tk 783-623-25	39	tk 783-659	40		
tk 783-228	39	tk 783-623-45	39	tk 783-659-25	40		
tk 783-228-25	39	tk 783-624	39	tk 783-659-45	40		
tk 783-228-45	39	tk 783-624-25	39	tk 783-710	38		
tk 783-229	41	tk 783-624-45	39	tk 783-711	38		
tk 783-229-25	41	tk 783-625	39	tk 783-720	38		
tk 783-229-45	41	tk 783-625-25	39	tk 783-721	38		
tk 783-230	41	tk 783-625-45	39	tk 783-730	38		
tk 783-230-25	41	tk 783-627	40	tk 783-731	38		
tk 783-230-45	41	tk 783-627-25	40	tk 783-740	38		
tk 783-232	41	tk 783-627-45	40	tk 783-741	38		
tk 783-232-25	41	tk 783-628	39	tk 783-750	38		
tk 783-232-45	41	tk 783-628-25	39	tk 783-751	38		
tk 783-245	40	tk 783-628-45	39	tk 791-150	90		
tk 783-245-25	40	tk 783-629	41	tk 791-151	90		
tk 783-245-45	40	tk 783-629-25	41	tk 791-152	90		
tk 783-250	41	tk 783-629-45	41	tk 791-153	90		
tk 783-250-25	41	tk 783-630	41	tk 791-154	90		
tk 783-250-45	41	tk 783-630-25	41	tk 791-155	90		
tk 783-251	40	tk 783-630-45	41	tk 791-156	90		
tk 783-251-25	40	tk 783-632	41	tk 791-157	90		
tk 783-251-45	40	tk 783-632-25	41	tk 791-161	91		
tk 783-252	40	tk 783-632-45	41	tk 791-170	91		
tk 783-252-25	40	tk 783-641	41	tk 791-174	91		
tk 783-252-45	40	tk 783-641-25	41	tk 791-175	91		

## Wichtige Hinweise

---

Dieser Katalog bleibt Eigentum der Firma TEKNO-MEDICAL Optik-Chirurgie GmbH, auch wenn dafür eine Schutzgebühr bezahlt wurde. Er kann von uns jederzeit zurückgefordert werden, wenn er gegen unsere Interessen und nicht zum Vertrieb und Einkauf von TEKNO Produkten verwendet wird. Auch behalten wir uns in solch einem Falle weitergehende Maßnahmen vor.

Der Nachdruck oder Kopieren dieses Kataloges – im Gesamten oder auch nur auszugsweise – ist ohne unsere schriftliche Genehmigung verboten. Modelländerungen vorbehalten. Gedruckt in der Bundesrepublik Deutschland

## Important notice

---

*This catalogue remains property of TEKNO-MEDICAL Optik-Chirurgie GmbH even if we have asked for a lending fee. We can at any time recall the catalogue, in case that it has been not used according to our interests, i.e. sale or purchase of TEKNO products. We preserve the right for further steps in that case.*

*Reproduction or copying of this catalogue in whole or in parts is forbidden without our written permission. Patterns are subject to change. Printed in Germany*

## Indications importantes

---

Ce catalogue reste la propriété de TEKNO-MEDICAL Optik-Chirurgie GmbH, même si nous avons demandé le paiement d'une taxe de protection. Nous pouvons demander le retour du catalogue dans le cas où celui-ci n'est pas utilisé conformément à nos intérêts, pour la vente ou l'achat de nos produits. Dans ce cas nous nous réservons le droits de mener des actions juridiques.

La reproduction ou la copie totale ou partielle de ce catalogue est interdite sans notre accord écrit. Sous réserve des modifications techniques. Imprimé en Allemagne

## Avisos importantes

---

*Este catálogo es propiedad de TEKNO-MEDICAL Optik-Chirurgie GmbH, aún en el caso de haber abonado por él una tasa de colaboración. Podemos solicitar la devolución del catálogo en caso de que no sea utilizado para la compra o venta de nuestros productos. En este caso nos reservamos el derecho de tomar medidas jurídicas.*

*La reproducción o copia total o parcial de este catálogo esta prohibido sin nuestro consentimiento escrito. Salvo modificaciones técnicas. Impreso en la República Federal de Alemania*

## Avvertenze importanti

---

Questo catalogo rimane proprietà della TEKNO-MEDICAL Optik-Chirurgie GmbH, anche se è stato rilasciato gratuitamente contro pagamento. Possiamo in ogni momento richiederlo indietro, in caso non stato usato in accordo con i nostri interessi (acquisto e vendita dei prodotti TEKNO-Medical). Ci riserviamo in questo caso il diritto di prendere ulteriori provvedimenti.

La copia o la riproduzione di questo catalogo in parte o nella sua totalità è vietata senza il nostro permesso scritto. Ci riserviamo la facoltà di cambiamenti nei modelli. Stampato in Germania



**TEKNO-MEDICAL Optik-Chirurgie GmbH**

Sattlerstrasse 11 · 78532 Tuttlingen, Germany

Telefon +49 (74 61) 1701-0 · Fax +49 (74 61) 1701-50

mail@tekno-medical.com · www.tekno-medical.com

© 12.2019 - TEKNO-MEDICAL Optik-Chirurgie GmbH

TEKNO is a registered trademark of TEKNO-MEDICAL Optik-Chirurgie GmbH